

MANUAL DE PERFILES **ESTRUCTURALES**



gerdaucorsa.com.mx



GERDAU CORSA

Hazlo en grande, piensa en acero.





VENTAJAS DE CONSTRUIR CON ACERO



Construcciones
altas



Modulación
y precisión



Estructura
sustentable



Estética
arquitectónica



Espacios
eficientes



Rápida
construcción



Estructuras ligeras,
seguras ante
eventos sísmicos



Remodelaciones
y ampliaciones



CALIDAD



MEDIO
AMBIENTE



SEGURIDAD
Y SALUD

ASISTENCIA **TÉCNICA**

Apoyamos a nuestra fuerza de ventas, **enfocados en el servicio a nuestros clientes.**
Ofreciéndoles los siguientes beneficios:



Visitas técnicas
a nuestras
plantas



Capacitaciones
especializadas



Asesoría sobre
el uso de
nuestros
productos



Conferencias
técnicas



Acompañamiento
durante
la construcción
de proyecto



Factibilidad y
rentabilidad de
proyectos
de acero

gerdaucorsa.com.mx





PLANTA DE PERFILES ESTRUCTURALES EN CD. SAHAGÚN, HIDALGO.

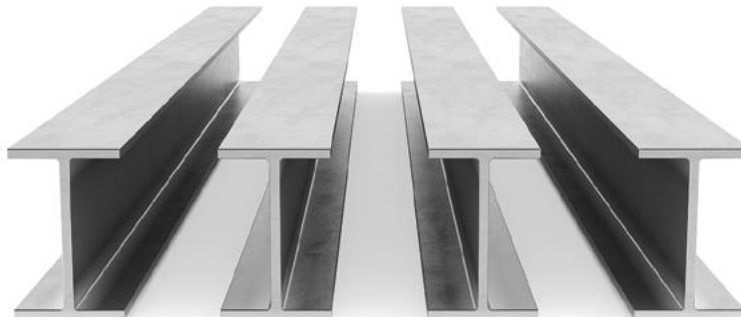

PERFILES ESTRUCTURALES

Tamaño (d x b)	kg/m (lb/ft)	Piezas x Paquete	Tamaño (d x b)	kg/m (lb/ft)	Piezas x Paquete	Tamaño (d x b)	kg/m (lb/ft)	Piezas x Paquete
6" X 4"	12.7 (#8.5)	24	12"X 6 1/2"	38.8 (#26)	8	18"X 7 1/2"	74.5 (#50)	4
	13.4 (#9)	24		44.7 (#30)	6		81.9 (#55)	3
	17.9 (#12)	18		52.1 (#35)	6		89.4 (#60)	3
	23.9 (#16)	12					96.8 (#65)	3
6" X 6"	22.4 (#15)	15	12"X 8"	59.6 (#40)	5	18" X 11 "	113.2 (#76)	3
	29.8 (#20)	9		67 (#45)	4		128.1 (#86)	2
	37.3 (#25)	9		74.5 (#50)	4		144.4 (#97)	2
							157.8 (#106)	2
8" X 4"	14.9 (#10)	20	12"X 10"	78.9 (#53)	4	21" X 6 1/2"	65.5 (#44)	4
	19.4 (#13)	15		86.4 (#58)	4		74.5 (#50)	4
	22.4 (#15)	15					84.9 (#57)	4
8" X 5 1/4"	26.8 (#18)	12	12"X 12"	96.8 (#65)	3		21" X 8 1/4"	71.5 (#48)
	31.3 (#21)	10		107.2 (#72)	3	81.9 (#55)		4
				117.6 (#79)	3	92.3 (#62)		3
				129.5 (#87)	2	101.3 (#68)		3
8"X 6 1/2"	35.8 (#24)	8	14"X 5"	32.8 (#22)	10	24"X 7"	81.9 (#55)	4
	41.7 (#28)	8		38.8 (#26)	8		92.3 (#62)	3
							108.7 (#73)	3
							123.6 (#83)	2
8"X 8"	46.2 (#31)	6	14"X 6 3/4"	44.7 (#30)	6	24" X 9"	101.3 (#68)	3
	52.1 (#35)	6		50.7 (#34)	6		113.2 (#76)	3
	59.6 (#40)	4		56.6 (#38)	4		125.1 (#84)	2
	71.5 (#48)	4					140.0 (#94)	2
10" X 4"	17.9 (#12)	18	14"X 8"	64.1 (#43)	4	16"X 5 1/2"	38.8 (#26)	8
	22.4 (#15)	15		71.5 (#48)	4		46.2 (#31)	6
	25.4 (#17)	12		78.9 (#53)	4			
	28.3 (#19)	9						
10" X 5 3/4"	32.8 (#22)	9	14"X10"	90.8 (#61)	3	16" X 7"	53.6 (#36)	6
	38.8 (#26)	6		101.3 (#68)	3		59.6 (#40)	5
	44.7 (#30)	6		110.2 (#74)	3		67 (#45)	4
				122.1 (#82)	2		74.5 (#50)	4
10" X 8"	49.2 (#33)	6	16"X 10 1/4"	99.8 (#67)	3	18"X 6"	52.1 (#35)	6
	58.1 (#39)	4		114.7 (#77)	3		59.6 (#40)	5
	67 (#45)	4		132.5 (#89)	2		68.5 (#46)	4
				148.9 (#100)	2			
10" X 10"	73 (#49)	4	18"X 6"	52.1 (#35)	6			
	80.4 (#54)	4		59.6 (#40)	5			
	89.4 (#60)	3		67 (#45)	4			
	101.3 (#68)	3		74.5 (#50)	4			
	114.7 (#77)	3		84.9 (#57)	4			
	131 (#88)	2						
148.9 (#100)	2							
166.8 (#112)	2							

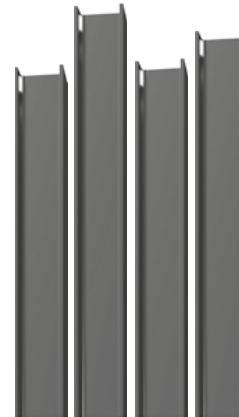

Nomenclatura:
d x b (in)

TABLA INFORMATIVA.
Para más información consulta nuestros artículos técnicos en nuestra página web:

gerdaucorsa.com.mx

¡Danos Like!
 Gerdau Corsa México

¡Síguenos!
 Gerdau Corsa Mx

¡Únete!
 Gerdau Corsa

¡Suscríbete!
 Gerdau Corsa



SOBRE NOSOTROS

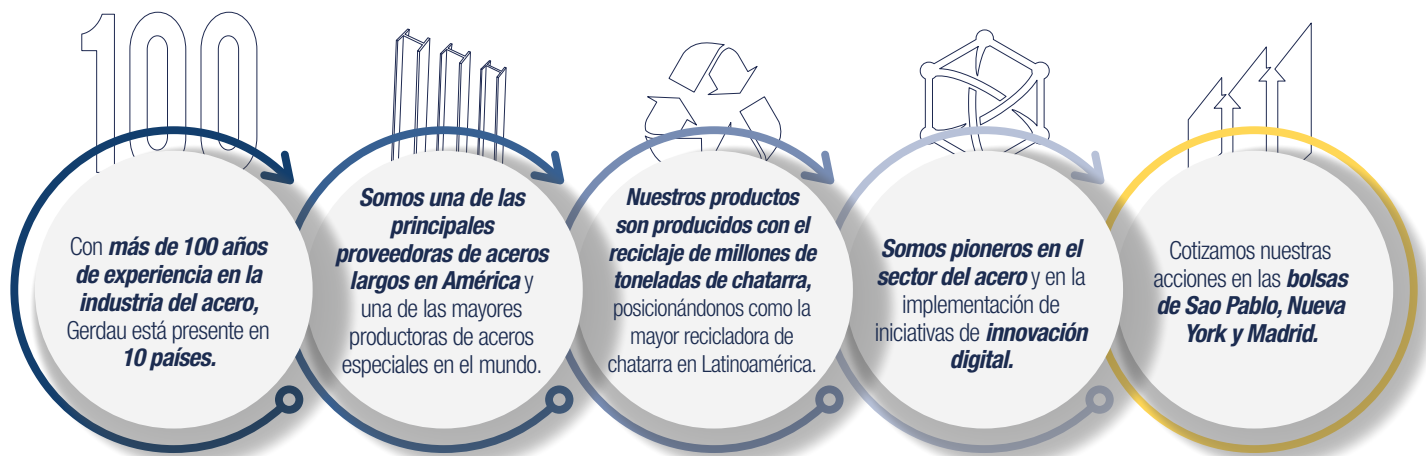

NUESTROS PRINCIPIOS



ACTUAR ÉTICAMENTE

Ética y respeto son esenciales en todo lo que hacemos.



SIMPLICIDAD

Nos enfocamos en lo que agrega valor. De esta manera somos más ágiles y ganamos eficiencia y productividad.



GENERAR VALOR PARA TODOS

Vivimos nuestro propósito generando valor para las partes interesadas de manera sustentable



TOMOS SOMOS LÍDERES

Estamos comprometidos con nuestro propio desarrollo y con el desarrollo de las personas a nuestro alrededor.



APRENDER, DESAPRENDER, REAPRENDER

Creemos que para seguir evolucionando, es esencial adaptarnos a nuevos escenarios, innovando y encontrando las mejores maneras de trabajar

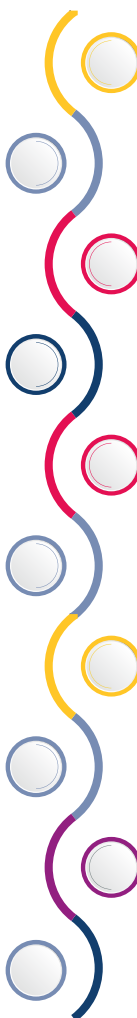

SEGURIDAD EN PRIMER LUGAR

Ningún resultado es más importante que la vida de las personas.



AUTONOMÍA

Somos responsables por tomar las mejores decisiones para el negocio.



AMBIENTE DIVERSO E INCLUSIVO

Respetamos y valoramos la diversidad. Creamos un ambiente diverso e inclusivo donde hay espacio para que todas las personas sean escuchadas, respetadas y tengan igualdad de oportunidades.



CADA CLIENTE ES ÚNICO

Trabajamos para hacer que el negocio de nuestro cliente prospere junto con el nuestro.



APERTURA

No sabemos todo y creemos que un equipo siempre logra mejores resultados que de manera individual.





GERDAU CORSA produce en México perfiles estructurales, perfiles comerciales y varilla corrugada para la construcción civil, construcción en acero y la industria especializada. **Nuestros productos son garantía de calidad**, pues cumplen con las especificaciones de las normas nacionales y extranjeras vigentes.

SOMOS UNA DE LAS PRINCIPALES
**PRODUCTORAS DE ACEROS
LARGOS EN EL PAÍS.**

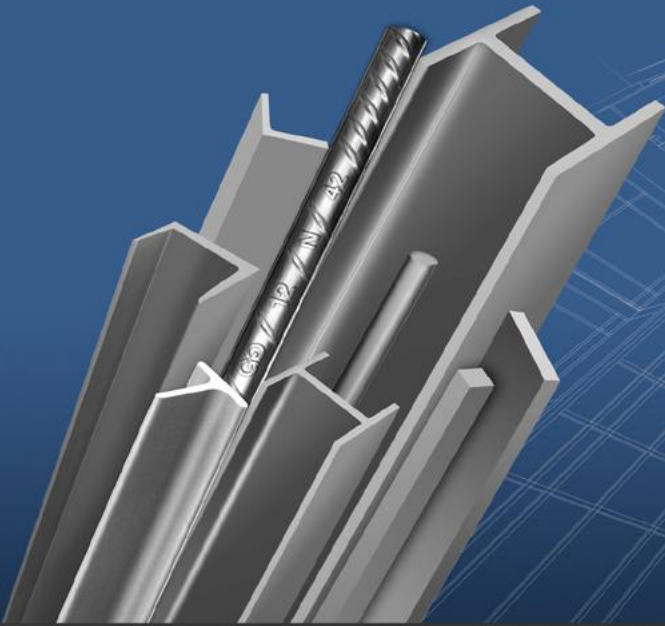

**NUESTRA LÍNEA
DE PRODUCTOS**
*Creamos productos dirigidos a
la construcción civil e industria.*

VIGA IR . VARILLA CORRUGADA . CANAL CE . SOLERA SOL . CUADRADO CS . REDONDO OS . ÁNGULO LI . PERFIL TR



SEGURIDAD

Para nosotros el ser humano en su integridad es un valor que está por encima de los demás objetivos y prioridades de la empresa. Ninguna situación de emergencia, producción o resultado puede comprometer la salud o la seguridad de las personas, la protección del medio ambiente y la calidad de los productos y servicios.



GESTIÓN AMBIENTAL

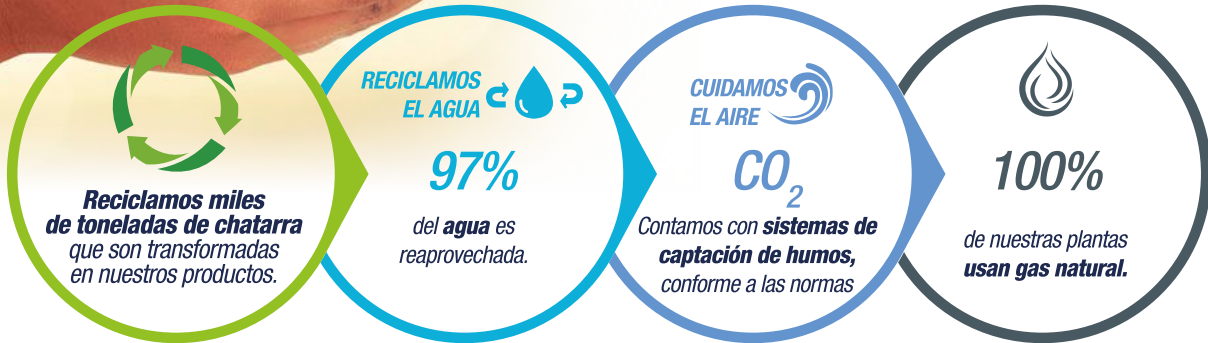

RESPONSABILIDAD SOCIAL

En **GERDAU CORSA** creemos en el desarrollo sostenible de las comunidades donde actuamos.

Por eso, desarrollamos programas sociales y alianzas con entidades representativas de la sociedad orientados a:



CALIDAD DE GESTIÓN



EDUCACIÓN



MOVILIZACIÓN SOLIDARIA





5. CONTENIDO DEL MANUAL

- 5.1 Producto perfil IR
- 5.2 Referencia normativa
- 5.3 Propiedades químicas
- 5.4 Características dimensionales
- 5.5 Propiedades mecánicas
- 5.6 Características superficiales
 - a. Oxidación
 - b. Corrosión
- 5.7 Identificación del producto
 - a. Quintado
 - b. Identificación por pintura
 - c. Identificación con etiqueta
- 5.8 Empaquetado y flejado
 - a. Piezas por atado
- 5.9 Embarque del material / manejo y almacenaje
- 5.10 Certificado de calidad
- 5.11 Política de seguridad, medio ambiente y calidad
- 5.12 Tablas de dimensiones y propiedades
- 5.13 Tolerancias de laminación
- 5.14 Cargas vivas
- 5.15 Observaciones

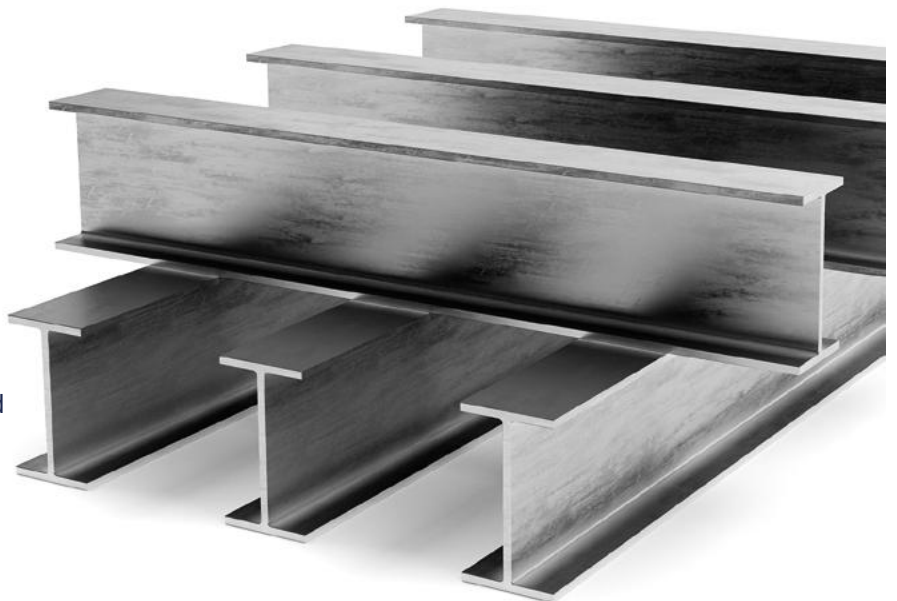

5.1 PERFIL IR

O también llamados perfiles W, H, M o Vigas

Aplicación: En construcción, tales como columnas, traves, vigas, postes y armaduras

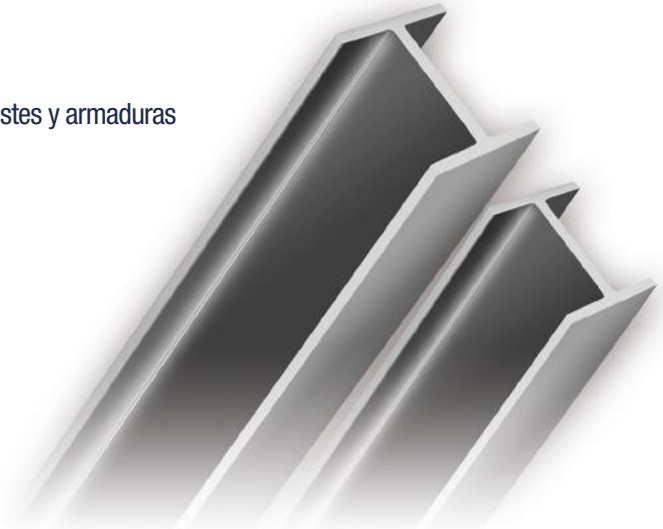
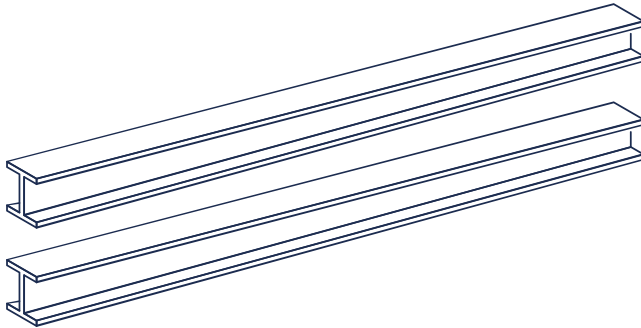

5.2 REFERENCIA NORMATIVA

- NMX-B-001-CANACERO** *Métodos de análisis químicos para determinar la composición de aceros y hierros
Métodos de prueba*
- NMX-B-120** *Prueba de impacto para materiales metálicos*
- NMX-B-172-CANACERO** *Métodos de prueba mecánicos para productos de acero*
- NMX-B-252** *Requisitos generales para placas, perfiles y tabla estacas de acero laminado para uso*
- NMX-B-284-CANACERO** *Acero estructural de alta resistencia baja aleación al manganeso-niobio-vanadio*
- NMX-B-307-CANACERO** *Métodos para estimar el tamaño promedio de grano*
- ASTM A6 / A6M** *Standard Specification for General Requirements for Rolled Structural Steel Bars, Plates, Shapes and Sheet Piling*
- ASTM A992 / A992M** *Standard Specification for Structural steel Shapes*
- ASTM A572 / A572M** *Standard Specification for High-Strength Low-Alloy Columbium-Vanadium Structural Steel*
- ASTM A709 / A709M** *Standard Specification for Structural Steel for Bridges*
- CSA G40-20 / G40-21** *General Requirements for Rolled or Welded Structural Quality Steel/Structural Quality Steel*

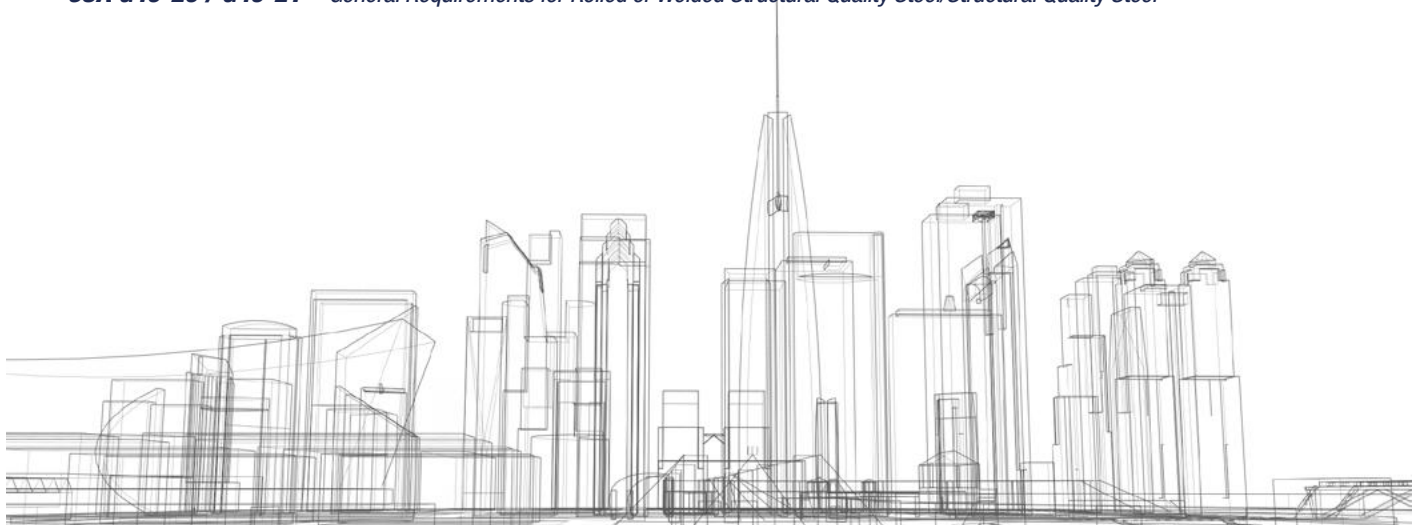

5.3 PROPIEDADES QUÍMICAS

PRUEBA DE PROPIEDADES QUÍMICAS

Se realiza un análisis químico a una probeta para obtener la composición química de la muestra con el cual se emite el certificado de calidad con los elementos químicos presentes en el producto, por medio de un espectrómetro de emisión óptica.

El acero de los Perfiles IR es producido de acuerdo con la especificación **ASTM A992 / A992M** y **ASTM A572 / A572M G50**

Elemento	ASTM A 572 - 50	ASTM A 992
C (máx)	0.23	0.23
Mn (máx)	1.35	0.50 - 1.60
P (máx)	0.04	0.035
S (máx)	0.05	0.045
Si (máx)	0.40	0.40
Cu (máx)	•••	0.60
Ni (máx)	•••	0.45
Cr (máx)	•••	0.35
Mo (máx)	•••	0.15
V (máx)	0.01 - 0.15	0.15
Cb o Nb (máx)	0.005 - 0.05	0.05

Tabla 1. Propiedades químicas del acero.

CARBONO EQUIVALENTE (CE INDICA LA SOLDABILIDAD DEL PRODUCTO DE ACERO)

El carbono equivalente máximo permisible es de 0.45 %, se debe calcular del análisis de colada y se reporta en el informe de pruebas. El CE se calcula utilizando la fórmula siguiente:

$$CE = C + MN / 6 + (CR + MO + V) / 5 + (NI + CU) / 15$$

5.4 CARACTERÍSTICAS DIMENSIONALES

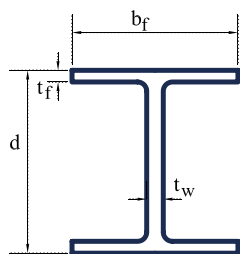

DIMENSIONES

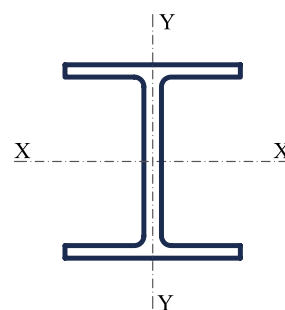

PROPIEDADES

- b_f Ancho del patín
- t_f Espesor de patín
- d Peralte de la viga
- t_w Espesor del alma

Figura 2. Características dimensionales de los Perfiles IR.



5.5 PROPIEDADES MECÁNICAS

Las propiedades mecánicas se obtienen por medio de un ensayo de tensión a través de una probeta obtenida del patín del producto y en algunos casos del alma conforme a la norma de prueba de tensión **ASTM A370 Standard Test Methods and Definitions for Mechanical Testing of Steel Products**.

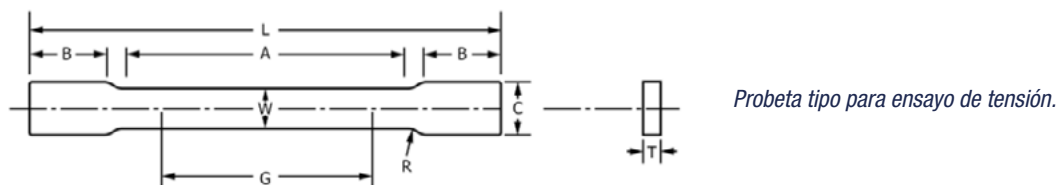

PRUEBA DE TENSIÓN AXIAL

El objetivo es determinar la resistencia a la ruptura y las principales propiedades mecánicas del material que es posible apreciar en el diagrama de esfuerzo-deformación. Éstas son:

- ✓ Límite elástico.
- ✓ Punto de fluencia.
- ✓ Límite de fluencia.
- ✓ Punto de fractura.

Comportamiento mecánico refleja la relación: $\frac{\text{esfuerzo aplicado}}{\text{deformación del material}}$

La respuesta de los materiales a las fuerzas aplicadas depende de:

- ✓ Tipo de enlace.
- ✓ Disposición estructural de los átomos o moléculas.
- ✓ Tipo y número de imperfecciones, que están siempre presentes en los sólidos, excepto en raras circunstancias.

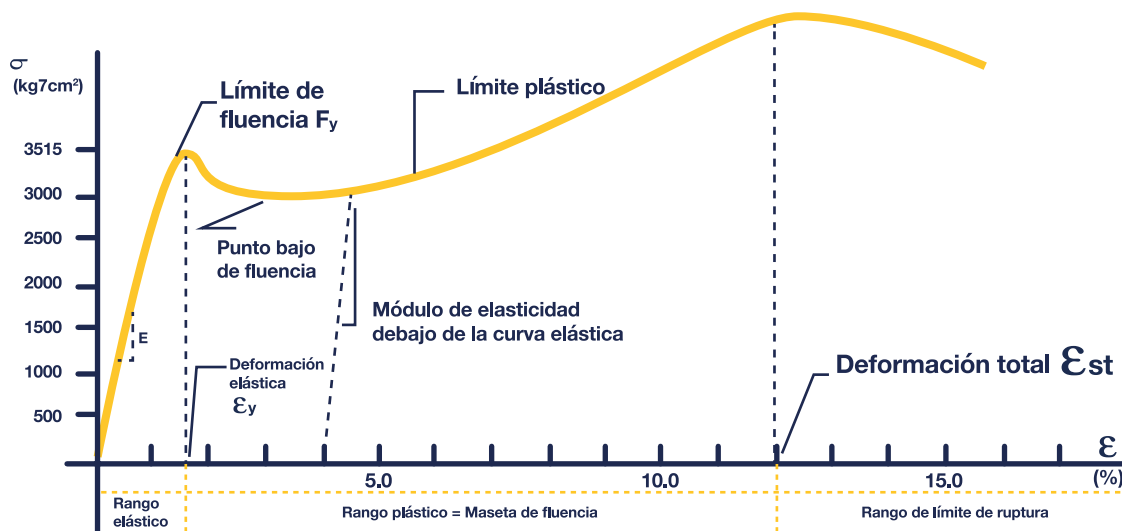

Elemento	ASTM A 572 - 50	ASTM A 992
F _y (kg/cm ²)	3515	3515 - 4570
F _u (kg/cm ²)	4570	4570 **
Elong. en 200 mm (mín,%)	18	18
Elong. en 50 mm (mín,%)	21	21

** La relación entre f_y / f_u, no excederá el valor de 0.85.

f_y Esfuerzo de Fluencia, kg/cm².

f_u Resistencia a la Ruptura por tensión kg/cm².

Cuando se indican 2 valores, el segundo es el máximo admisible

Fuente: ASTM Volume 01.04 2009

Figura 3. Gráfica esfuerzo-deformación.

5.6 CARACTERÍSTICAS SUPERFICIALES

OXIDACIÓN. *La oxidación es un proceso natural del acero que se produce cuando el oxígeno se combina con metal.*

Este es un proceso natural de los productos.

CORROSIÓN. *El deterioro de un material a consecuencia de un ataque electroquímico por su entorno. GUIA g101.*

De manera más general, puede entenderse como la tendencia general que tienen los materiales a buscar su forma más estable o de menor energía interna.

Otros materiales no metálicos también sufren corrosión mediante otros mecanismos.



5.7 IDENTIFICACIÓN DEL PRODUCTO

Los perfiles deberán estar identificados de la siguiente manera:

1) QUINTADO

- Marcación en el alma del perfil laminado en caliente durante el proceso de laminación.
- Esta marca es obligatoria regulada por la norma ASTM A6 referenciado en el punto 18.2.1 "Identification of Structural Products".
- Marca para productos mayores a 6 pulgadas de peralte.
- Identificación con letras superiores a la superficie del patín el nombre del molino.



Figura 4. Ejemplo de Quintado de Perfil.

2) IDENTIFICACIÓN POR PINTURA:

- Esta marcación es realizada a través de una marcadora de pintura automatizada y sincronizada con los datos de proceso.
- Se ubica sobre la línea de acabados, donde coloca en cada perfil medida y número de lote o colada.
- Esta marca es obligatoria regulada por la norma ASTM A6/A6M y ASTM A992 referenciado en el punto 18.2.1 "Identification of structural products".



Figura 5. Ejemplo de marca con tinta.

3) IDENTIFICACIÓN CON ETIQUETA.

La identificación con etiqueta es realizada por paquete en el perfil superior del atado en el centro del alma.

La información que contiene es:

- ✓ Medida del perfil.
- ✓ Norma de fabricación.
- ✓ Peso en kg y lb.
- ✓ Longitud en m y ft.
- ✓ Fecha de fabricación.
- ✓ ID de paquete.
- ✓ Colada o lote.
- ✓ Dirección de la planta.
- ✓ Código de barras.
- ✓ Número de atención a clientes.
- ✓ HECHO EN MÉXICO español/inglés.



Figura 6. Ejemplo de Etiqueta.

5.8 EMPAQUETADO Y FLEJADO

PIEZAS POR ATADO.

El número de piezas en un paquete está determinado por:

- Las dimensiones máximas del empaquetador son 900x900 mm.
- El peso máximo de cada paquete es 4 toneladas.



Figura 7. Ejemplo de flejado y empaquetado.

El correcto manejo del producto, así como su almacenaje, ayuda a garantizar la integridad del material; esto con la separación de los paquetes, utilizando polines entre ellos.



Figura 8. Ejemplo de manejo y almacenaje físico

5.9 EMBARQUE DE MATERIAL / MANEJO Y ALMACENAJE

- El empaquetado de perfiles se realiza en forma de "H".
- Garantiza la estabilidad y seguridad en el manejo y traslado de los paquetes.



Figura 9. Ejemplo de manejo y almacenaje.

5.10 CERTIFICADO DE CALIDAD

Cada uno de los productos fabricados son probados conforme a la **Norma ASTM A6/A6M Standard Specification for General Requirements for Rolled Structural Steel Bars, Plates, Shapes, and Sheet Piling 1**.

Los resultados se colocan en un certificado de calidad que es emitido en cada nota fiscal de venta.

Cada certificado de calidad expedido incluye la siguiente información:

- **Número de lote o colada.**
- **Medida de producto.**
- **Normas con las que cumple el producto.**
- **Composición química.**
- **Propiedades mecánicas.**





GERDAU CORSA SAPI DE CV
 KM. 3 CARRETERA MÉXICO - SAHAG
 GERDAU CORSA SAPI DE CV, MEXICO
 43990
 SAHAGÚN

CERTIFICADO DE CALIDAD

Página 1/1

CLIENTE A ENVIAR		CLIENTE A FACTURAR		GRADO ASTM A992/A572 G50	PRODUCTO / MEDIDA Wide Flange Beam / 24 X 103# / 610 X 153.4	CERTIFICATE ID 0000062090						
PEDIDO DE VENTA 6647876/000110		CUSTOMER MATERIAL N°		LONGITUD 18.30M	PESO 5,610 KG	COLADA / LOTE 11010143/03						
ORDEN DE COMPRA DEL CLIENTE		CARTA DE EMBARQUE		FECHA 04.09.2018								
ESPECIFICACIÓN TÉCNICA ASTM A572/A572M -13 ASTM A6/A6M - 14 ASTM A992-11 (2015) CSA G40.21-13345WM												
COMPOSICIÓN QUÍMICA												
C %	Mn %	S %	P %	Cr %	Cu %	Mo %	Nb %	Ni %	Si %	V %	C.E.	Pb %
0.082	1.199	0.032	0.034	0.103	0.202	0.019	0.001	0.062	0.236	0.042	0.332	0.000
COMPOSICIÓN QUÍMICA												
Su %												
0.015												
PROPIEDADES MECÁNICAS												
YS/FY KSI		UTS/FU KSI		Elong. %	UTS/FU MPa		YS/FY MPa		G/L mm			
54.3		69.0		25.0	476.1		375.0		200			
58.2		74.0		27.5	510.2		401.7		200			
PROPIEDADES MECÁNICAS												
YS/UTS												
0.78												
0.78												
COMENTARIOS / NOTAS												

CARLOS MOSS VELEZ

Figura 10. Ejemplo de certificado de calidad.



Política Integrada

Salud y Seguridad, Medio Ambiente y Calidad

Para Gerdau Corsa, el ser humano en su integridad es un valor que está por encima de los demás objetivos y prioridades de la empresa. Ninguna situación de emergencia, producción o resultado puede comprometer la salud o la seguridad de las personas, la protección del medio ambiente y la calidad de los productos y servicios.

Gerdau Corsa, proveedora de soluciones y productos de acero, busca la satisfacción de accionistas, clientes, colaboradores, proveedores y comunidades por medio de la mejora continua de estos productos y servicios, procesos y sistema de gestión. Para esto, actúa comprometida con la calidad, con el control de los riesgos de salud y de seguridad de los colaboradores y con la gestión de aspectos y prevención de impactos ambientales. Sus acciones son siempre fundamentadas en objetivos y metas de desempeño y en el cumplimiento consistente de la legislación aplicable y los compromisos asumidos, buscando el desarrollo sostenible (ambiental, social y económico).

Principios:

- El liderazgo es el principal responsable por la seguridad de todas las personas que actúan bajo su gestión, promoviendo todos los esfuerzos necesarios para preservar la salud y la seguridad de las personas, el desarrollo sostenible y la productividad y eficiencia de los procesos.
- Cada colaborador tiene la responsabilidad de cuidar por su salud y su seguridad, así como por las de sus colegas, por el medio ambiente y por la calidad de los productos y servicios. Debe realizar su trabajo de acuerdo con los procedimientos, instrucciones, normas y reglas establecidas por la empresa.
- Gerdau Corsa y todos sus colaboradores se comprometen en la búsqueda de la mejora continua en relación a la salud y la seguridad de las personas, el medio ambiente, la eficacia de los procesos y la satisfacción de los clientes con la calidad de los productos y servicios. Los esfuerzos deben ser orientados a las acciones de prevención, buscando y compartiendo las mejores prácticas y utilizando de forma efectiva el aprendizaje en toda la Organización.

Gustavo Werneck
Director Presidente



ÁNGULO DE LADOS IGUALES ESTÁNDAR

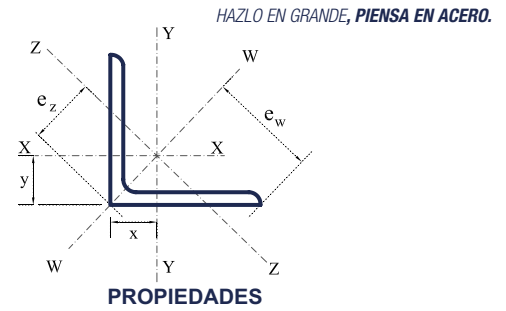
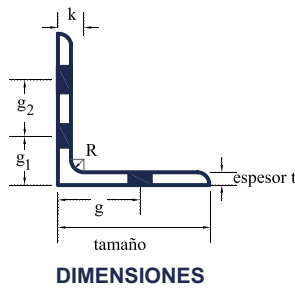

HAZLO EN GRANDE, PIENSA EN ACERO.

Designación tamaño x espesor	Peso	k	R	Gramil			Sujetadores			Propiedades de Torsión			Área	Ejes X-X y Y-Y				Eje W-W				Eje Z-Z			
				g	g1	g2	Diámetro Máximo	Espac. Recom.	J	Cw	ro	I		S	r	x=y	I	S	r	ew	I	S	r	ez	
				mm	mm	mm	mm	mm	cm ⁴	cm ⁶	cm	cm ²		cm ⁴	cm ³	cm	cm ⁴	cm ³	cm	cm	cm ⁴	cm ³	cm	cm	
LI 19 x 3	0.88	11.1	3.2	11	-	-	6.3	1/4	20	0.04	0.01	1.16	1.11	0.37	0.3	0.58	0.58	0.58	0.43	0.73	1.34	0.16	0.19	0.38	0.82
LI 25 x 3	1.19	11.1	3.2	14	-	-	9.5	3/8	30	0.05	0.02	1.54	1.52	0.92	0.5	0.79	0.76	1.24	0.69	0.93	1.79	0.41	0.38	0.48	1.07
LI 25 x 5	1.73	12.7	3.2	14	-	-	9.5	3/8	30	0.17	0.07	1.56	2.21	1.25	0.7	0.76	0.81	2.08	1.16	0.93	1.79	0.41	0.36	0.48	1.14
LI 25 x 6	2.22	14.3	3.2	14	-	-	9.5	3/8	30	0.41	0.16	1.61	2.80	1.54	0.9	0.74	0.86	2.49	1.39	0.91	1.79	0.83	0.69	0.48	1.21
LI 32 x 3	1.50	11.1	4.7	18	-	-	12.7	1/2	40	0.07	0.05	1.87	1.93	1.83	0.8	0.97	0.89	2.91	1.30	1.19	2.24	0.83	0.66	0.60	1.25
LI 32 x 5	2.20	12.7	4.7	18	-	-	12.7	1/2	40	0.22	0.15	1.92	2.79	2.54	1.2	0.97	0.97	3.74	1.67	1.19	2.24	0.83	0.61	0.60	1.37
LI 32 x 6	2.86	14.3	4.7	18	-	-	12.7	1/2	40	0.51	0.33	1.95	3.72	3.21	1.5	0.94	1.02	4.99	2.23	1.16	2.24	1.24	0.86	0.60	1.44
LI 38 x 3	1.83	11.1	4.7	20	-	-	12.7	1/2	40	0.08	0.09	2.25	2.34	3.25	1.2	1.17	1.07	5.41	2.01	1.47	2.69	1.24	0.82	0.73	1.51
LI 38 x 4	2.25	11.1	4.7	20	-	-	12.7	1/2	40	0.15	0.16	2.27	2.86	3.92	1.4	1.17	1.10	6.24	2.32	1.48	2.69	1.60	1.03	0.73	1.55
LI 38 x 5	2.68	12.7	4.7	20	-	-	12.7	1/2	40	0.27	0.27	2.28	3.43	4.58	1.6	1.17	1.12	7.07	2.63	1.44	2.69	1.66	1.05	0.73	1.58
LI 38 x 6	3.48	14.3	4.7	20	-	-	12.7	1/2	40	0.62	0.61	2.34	4.40	5.83	2.2	1.14	1.19	8.74	3.24	1.42	2.69	2.49	1.48	0.73	1.68
LI 44 x 3	2.14	11.1	6.3	25	-	-	15.9	5/8	50	0.09	0.14	2.63	2.74	5.41	1.6	1.40	1.22	8.73	2.78	1.72	3.14	2.08	1.21	0.86	1.72
LI 44 x 4	2.65	11.1	6.3	25	-	-	15.9	5/8	50	0.18	0.27	2.64	3.37	6.37	2.0	1.37	1.26	10.15	3.23	1.74	3.14	2.59	1.45	0.86	1.78
LI 44 x 5	3.15	12.7	6.3	25	-	-	15.9	5/8	50	0.31	0.45	2.66	4.03	7.49	2.3	1.37	1.30	11.65	3.71	1.70	3.14	2.91	1.59	0.86	1.83
LI 44 x 6	4.12	14.3	6.3	25	-	-	15.9	5/8	50	0.73	1.00	2.71	5.20	9.57	3.1	1.35	1.35	14.56	4.64	1.67	3.14	3.74	1.97	0.86	1.90
LI 51 x 3	2.46	11.1	6.3	30	-	-	15.9	5/8	50	0.11	0.21	3.00	3.10	7.91	2.1	1.60	1.40	12.49	3.48	1.97	3.58	3.32	1.68	0.99	1.97
LI 51 x 4	3.04	11.1	6.3	30	-	-	15.9	5/8	50	0.21	0.40	3.00	3.87	9.66	2.6	1.58	1.42	15.41	4.29	1.99	3.58	3.91	1.95	0.99	2.00
LI 51 x 5	3.63	12.7	6.3	30	-	-	15.9	5/8	50	0.36	0.68	3.03	4.61	11.45	3.1	1.57	1.45	17.48	4.88	1.95	3.58	4.57	2.28	0.99	2.00
LI 51 x 6	4.75	14.3	6.3	30	-	-	15.9	5/8	50	0.84	1.54	3.05	6.06	14.57	4.1	1.55	1.50	22.47	6.27	1.93	3.58	5.82	2.77	0.99	2.10
LI 51 x 8	5.83	15.9	6.3	30	-	-	15.9	5/8	50	1.63	2.85	3.08	7.42	17.46	4.9	1.52	1.55	26.63	7.43	1.90	3.58	7.07	3.24	0.99	2.18
LI 51 x 10	6.99	17.5	6.3	30	-	-	15.9	5/8	50	2.79	4.68	3.14	8.77	19.98	5.7	1.50	1.63	30.80	8.60	1.87	3.58	8.32	3.61	0.99	2.30
LI 64 x 4	3.83	11.1	6.3	35	-	-	19	3/4	60	0.26	0.81	3.74	4.88	19.44	4.2	1.98	1.73	31.10	6.93	2.52	4.49	7.84	3.20	1.24	2.45
LI 64 x 5	4.61	12.7	6.3	35	-	-	19	3/4	60	0.45	1.37	3.74	5.81	22.89	4.9	1.98	1.75	36.62	8.15	2.46	4.49	9.15	3.70	1.24	2.47
LI 64 x 6	6.10	14.3	6.3	35	-	-	19	3/4	60	1.06	3.12	3.78	7.68	29.14	6.4	1.96	1.83	45.36	10.10	2.43	4.49	11.65	4.58	1.24	2.54
LI 64 x 8	7.44	15.9	6.3	35	-	-	19	3/4	60	2.05	5.86	3.81	9.48	35.38	7.9	1.93	1.88	55.35	12.32	2.41	4.49	14.56	5.51	1.24	2.64
LI 64 x 10	8.78	17.5	6.3	35	-	-	19	3/4	60	3.52	9.73	3.84	11.16	40.79	9.3	1.91	1.93	64.09	14.27	2.38	4.49	17.06	6.29	1.24	2.71
LI 64 x 13	11.39	20.6	6.3	35	-	-	19	3/4	60	8.24	21.24	3.93	14.52	51.09	11.9	1.88	2.05	79.99	17.82	2.35	4.49	22.18	7.67	1.24	2.89
LI 76 x 5	5.52	12.7	7.9	45	-	-	22.2	7/8	70	0.54	2.41	4.48	7.03	40.01	7.2	2.39	2.08	64.38	11.97	3.03	5.38	16.12	5.48	1.51	2.94
LI 76 x 6	7.29	14.3	7.9	45	-	-	22.2	7/8	70	1.27	5.54	4.49	9.29	51.60	9.5	2.36	2.13	78.66	14.62	2.94	5.38	20.39	6.86	1.49	2.97
LI 76 x 8	9.08	15.9	7.9	45	-	-	22.2	7/8	70	2.47	10.47	4.55	11.48	62.90	11.6	2.34	2.21	96.98	18.02	2.92	5.38	24.97	8.21	1.47	3.04
LI 76 x 10	10.72	17.5	7.9	45	-	-	22.2	7/8	70	4.25	17.50	4.58	13.61	73.30	13.6	2.31	2.26	112.79	20.96	2.89	5.38	29.55	9.41	1.47	3.14
LI 76 x 13	13.99	20.6	7.9	45	-	-	22.2	7/8	70	9.97	38.78	4.64	17.74	92.40	17.5	2.29	2.36	142.76	26.53	2.84	5.38	38.29	11.53	1.47	3.32
LI 89 x 6	8.63	14.3	8.3	50	-	-	22.2	7/8	70	1.49	8.96	5.24	10.90	83.66	13.0	2.77	2.46	133.53	21.26	3.50	6.29	33.79	9.71	1.76	3.48
LI 89 x 8	10.71	15.9	8.1	50	-	-	22.2	7/8	70	2.90	17.02	5.27	13.48	101.95	16.0	2.74	2.51	162.49	25.87	3.47	6.29	41.41	11.66	1.75	3.55
LI 89 x 10	12.65	17.5	8.0	50	-	-	22.2	7/8	70	4.98	28.60	5.30	16.00	119.46	18.8	2.72	2.57	191.20	30.44	3.47	6.29	50.22	13.87	1.74	3.63
LI 89 x 11	14.52	20.6	8.0	50	-	-	22.2	7/8	70	7.88	44.13	5.34	18.52	135.69	21.7	2.71	2.63	215.39	34.26	3.41	6.29	55.99	15.05	1.74	3.72
LI 89 x 13	16.52	20.6	7.6	50	-	-	22.2	7/8	70	11.71	64.02	5.38	20.97	151.51	24.4	2.69	2.69	238.09	37.91	3.37	6.29	61.59	16.21	1.73	3.80
LI 89 x 19	23.74	20.6	7.6	50	-	-	22.2	7/8	70	38.78	192.07	5.53	30.24	206.45	34.5	2.61	2.91	322.13	51.24	3.26	6.29	90.77	22.07	1.73	4.11
LI 102 x 5	7.42	14.3	9.5	60	-	-	22.2	7/8	70	0.72	5.86	5.30	9.54	64.38	8.6	2.60	2.70	119.09	15.96	3.53	7.18	9.67	1.30	1.01	3.82
LI 102 x 6	9.82	15.9	9.5	60	-	-	22.2	7/8	70	1.71	13.56	5.94	12.52	124.9	17.2	3.18	2.77	191.89	26.72	3.96	7.18	48.10	12.30	2.00	3.91
LI 102 x 8	12.20	17.5	9.5	60	-	-	22.2	7/8	70	3.32	25.86	6.01	15.48	154.4	21.1	3.15	2.84	239.33	33.33	3.93	7.18	61.60	15.36	2.00	4.01
LI 102 x 10	14.58	19.1	9.5	60	-	-	22.2	7/8	70	5.72	43.60	6.03	18.45	181.5	24.9	3.12	2.89	283.03	39.41	3.91	7.18	73.25	18.17	1.98	4.03
LI 102 x 11	16.82	20.6	9.5	60	-	-	22.2	7/8	70	9.04	67.54	6.06	21.35	206.9	28.7	3.12	2.94	322.99	44.98	3.88	7.18	83.66	20.15	1.98	4.15
LI 102 x 13	19.05	22.2	9.5	60	-	-	22.2	7/8	70	13.44	98.34	6.08	24.19	231.4	32.3	3.10	2.99	361.28	50.31	3.86	7.18	94.48	22.44	1.98	4.21
LI 102 x 16	23.36	25.4	9.5	60	-	-	22.2	7/8	70	26.04	182.														



ÁNGULO DE LADOS IGUALES ESTÁNDAR

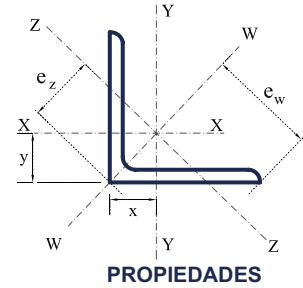
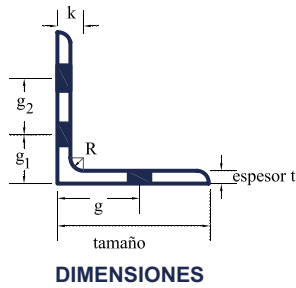

PERFIL	Designación tamaño x espesor		Peso	k	R	Gramil			Sujetadores		Propiedades de Torsión			Área	Ejes X-X y Y-Y				Eje W-W				Eje Z-Z				
	mm* x mm*	in x in				g	g ₁	g ₂	Diámetro Máximo	Espac. Recom.	J	C _w	r _o		I	S	r	x=y	I	S	r	e _w	I	S	r	e _z	
	mm* x mm*	in x in	kg/m	mm	mm	mm	mm	mm	mm	in	mm	cm ⁴	cm ⁶	cm	cm ²	cm ⁴	cm ³	cm	cm	cm ⁴	cm ³	cm	cm	cm ⁴	cm ³	cm	cm
LI	152 x 10	6 x 3/8	22.17	22.2	12.7	90	60	60	25.4	1	90	8.64	154.49	8.95	28.13	640.6	57.8	4.78	4.16	1018.6	94.6	6.02	10.76	262.60	44.7	3.05	5.88
LI	152 x 13	6 x 1/2	29.17	25.4	12.7	90	60	60	25.4	1	90	20.38	354.52	9.01	37.10	828.7	75.5	4.72	4.27	1326.1	123.3	5.97	10.76	331.30	54.9	2.99	6.03
LI	152 x 16	6 x 5/8	36.01	28.6	12.7	90	60	60	25.4	1	90	39.59	670.09	9.08	45.87	1005.6	92.8	4.67	4.39	1604.8	149.2	5.92	10.76	406.40	65.6	2.98	6.20
LI	152 x 19	6 x 3/4	42.71	31.8	12.7	90	60	60	25.4	1	90	68.04	1120.16	9.16	54.45	1171.7	109.1	4.65	4.52	1859.2	172.7	5.85	10.76	484.20	75.9	2.98	6.38
LI	152 x 25	6 x 1	55.66	38.1	12.7	90	60	60	25.4	1	90	159.56	2482.09	9.28	70.97	1476.0	140.0	4.57	4.72	2327.8	203.3	5.73	10.76	624.20	93.7	2.96	6.66
LI	203 x 13	8 x 1/2	39.3	29.0	12.7	120	80	80	25.4	1	100	27.32	868.05	11.94	50.00	2024.1	137.1	6.36	5.55	3232.5	225.0	8.04	14.37	815.69	103.9	4.04	7.85
LI	203 x 16	8 x 5/8	48.7	32.0	12.7	120	80	80	25.4	1	100	53.14	1654.72	12.00	62.08	2474.0	169.0	6.32	5.67	3946.0	275.0	7.98	14.37	1001.20	124.9	4.02	8.01
LI	203 x 19	8 x 3/4	57.9	35.0	12.7	120	80	80	25.4	1	100	91.46	2790.19	12.06	73.79	2902.7	199.7	6.27	5.78	4624.3	321.8	7.92	14.37	1181.15	144.4	4.00	8.18
LI	203 x 22	8 x 7/8	67.1	38.0	12.7	120	80	80	25.4	1	100	144.65	4322.65	12.13	85.38	3312.0	230.0	6.23	5.90	5268.0	366.7	7.86	14.37	1356.60	162.7	3.99	8.34
LI	203 x 25	8 x 1	75.9	41.0	12.7	120	80	80	25.4	1	100	215.05	6293.81	12.20	96.77	3703.8	258.8	6.19	6.01	5879.3	409.2	7.79	14.37	1528.26	179.8	3.97	8.50
LI	203 x 29	8 x 1 1/8	84.8	44.0	12.7	120	80	80	25.4	1	100	304.96	8739.13	12.27	107.96	4078.0	287.0	6.15	6.12	6458.0	449.5	7.73	14.37	1697.10	195.9	3.96	8.66

- ASTM A36 / A36M $f_y = 2,530 \text{ kg/cm}^2$
- ASTM A529 / A529M G50 $f_y = 3,515 \text{ kg/cm}^2$
- ASTM A572 / A572M G50 $f_y = 3,515 \text{ kg/cm}^2$
- ASTM A572 / A572M G60 $f_y = 4,200 \text{ kg/cm}^2$

Los productos en franja amarilla, son de existencia frecuente.

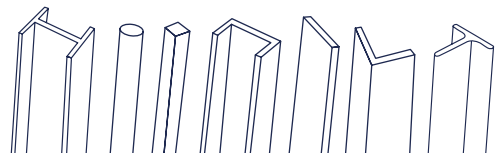



APS
ÁNGULO DE LADOS IGUALES
MILÉSIMAS DE PULGADA

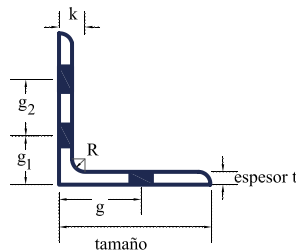

DIMENSIONES

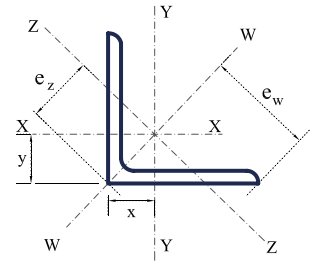

PROPIEDADES

Designación tamaño x espesor	Peso	k	R	Gramil			Sujetadores			Propiedades de Torsión				Ejes X - X y Y - Y				Eje W - W				Eje Z - Z			
				g	Diámetro Máximo	Espac. Recomend.	J	C _w	r _o	Área	I	S	r	x = y	I	S	r	e _w	I	S	r	e _z			
PERFIL	in x in	kg/m	mm	mm	mm	mm	in	mm	cm ⁴	cm ⁶	cm	cm ²	cm ⁴	cm ³	cm	cm	cm ⁴	cm ³	cm	cm	cm ⁴	cm ³	cm	cm	
L 2 x 0.125	2.45	11.1	6.3	30	15.9	5/8	50	0.107	0.212	3.004	3.10	7.91	2.13	1.60	1.40	12.49	3.48	1.97	3.58	3.32	1.68	0.99	1.97		
L 2 x 0.130	2.55	11.1	6.3	30	15.9	5/8	50	0.120	0.237	2.988	3.25	8.19	2.22	1.59	1.39	13.08	3.64	2.01	3.59	3.30	1.68	1.01	1.97		
L 2 x 0.138	2.70	11.1	6.3	30	15.9	5/8	50	0.143	0.282	2.991	3.44	8.65	2.35	1.59	1.40	13.80	3.84	2.00	3.59	3.49	1.76	1.01	1.98		
L 2 x 0.143	2.79	11.1	6.3	30	15.9	5/8	50	0.159	0.313	2.994	3.56	8.93	2.43	1.58	1.40	14.25	3.97	2.00	3.59	3.61	1.82	1.01	1.99		
L 2 x 0.145	2.83	11.1	6.3	30	15.9	5/8	50	0.166	0.326	2.995	3.61	9.04	2.46	1.58	1.41	14.43	4.02	2.00	3.59	3.65	1.84	1.01	1.99		
L 2 x 0.156	3.04	11.1	6.3	30	15.9	5/8	50	0.207	0.402	3.000	3.87	9.66	2.64	1.58	1.42	15.41	4.29	1.99	3.59	3.91	1.95	0.99	2.00		
L 2 x 0.163	3.17	11.1	6.3	30	15.9	5/8	50	0.235	0.456	3.004	4.04	10.03	2.74	1.58	1.42	16.00	4.45	1.99	3.59	4.06	2.02	1.00	2.01		
L 2 x 0.166	3.22	12.7	6.3	30	15.9	5/8	50	0.249	0.481	3.005	4.11	10.19	2.79	1.58	1.43	16.26	4.53	1.99	3.59	4.13	2.05	1.00	2.02		
L 2 x 0.170	3.30	12.7	6.3	30	15.9	5/8	50	0.267	0.515	3.007	4.20	10.41	2.85	1.57	1.43	16.60	4.62	1.99	3.59	4.22	2.09	1.00	2.02		
L 2 x 0.177	3.43	12.7	6.3	30	15.9	5/8	50	0.301	0.578	3.011	4.37	10.78	2.96	1.57	1.44	17.19	4.79	1.98	3.59	4.38	2.16	1.00	2.03		
L 2 x 0.187	3.61	12.7	6.3	30	15.9	5/8	50	0.354	0.676	3.029	4.61	11.45	3.11	1.57	1.45	17.48	4.88	1.95	3.58	4.57	2.28	0.99	2.00		
L 2 x 0.200	3.85	12.7	6.3	30	15.9	5/8	50	0.433	0.819	3.023	4.90	11.99	3.31	1.56	1.46	19.09	5.31	1.97	3.59	4.89	2.37	1.00	2.06		
L 2 x 0.203	3.90	12.7	6.3	30	15.9	5/8	50	0.452	0.854	3.024	4.97	12.14	3.35	1.56	1.46	19.33	5.38	1.97	3.59	4.96	2.40	1.00	2.06		
L 2 x 0.205	3.94	12.7	6.3	30	15.9	5/8	50	0.466	0.878	3.025	5.02	12.24	3.38	1.56	1.46	19.49	5.43	1.97	3.59	5.00	2.42	1.00	2.07		
L 2 x 0.217	4.16	12.7	6.3	30	15.9	5/8	50	0.552	1.032	3.032	5.30	12.85	3.56	1.56	1.47	20.44	5.69	1.96	3.59	5.26	2.53	1.00	2.08		
L 2 x 0.232	4.43	14.3	6.3	30	15.9	5/8	50	0.673	1.246	3.040	5.64	13.60	3.78	1.55	1.49	21.61	6.02	1.96	3.59	5.59	2.66	1.00	2.10		
L 2 x 0.247	4.69	14.3	6.3	30	15.9	5/8	50	0.810	1.485	3.048	5.98	14.32	4.00	1.55	1.50	22.74	6.33	1.95	3.59	5.91	2.78	0.99	2.12		
L 2 x 0.250	4.75	14.3	6.3	30	15.9	5/8	50	0.840	1.537	3.051	6.06	14.57	4.10	1.55	1.50	22.47	6.27	1.93	3.58	5.82	2.77	0.99	2.10		
L 2 x 0.280	5.27	14.3	6.3	30	15.9	5/8	50	1.176	2.107	3.067	6.72	15.87	4.47	1.54	1.53	25.14	7.00	1.93	3.59	6.60	3.05	0.99	2.16		
L 2 x 0.313	5.84	15.9	6.3	30	15.9	5/8	50	1.635	2.866	3.084	7.42	17.46	4.92	1.52	1.55	26.63	7.43	1.9	3.58	7.07	3.24	0.99	2.18		
L 2 x 0.375	6.88	17.5	6.3	30	15.9	5/8	50	2.789	4.684	3.142	8.77	20.0	5.7	1.5	1.6	30.8	8.6	1.9	3.6	8.3	3.6	1.0	2.3		
L 2 1/2 x 0.156	3.83	11.1	6.3	35	19.0	3/4	60	0.259	0.805	3.732	4.88	19.28	4.18	1.99	1.73	30.78	6.86	2.51	4.49	7.77	3.17	1.26	2.45		
L 2 1/2 x 0.163	3.99	11.1	6.3	35	19.0	3/4	60	0.296	0.914	3.735	5.09	20.06	4.35	1.99	1.74	32.03	7.13	2.51	4.49	8.09	3.29	1.26	2.46		
L 2 1/2 x 0.170	4.16	11.1	6.3	35	19.0	3/4	60	0.335	1.032	3.738	5.30	20.84	4.53	1.98	1.75	33.26	7.41	2.51	4.49	8.41	3.40	1.26	2.47		
L 2 1/2 x 0.188	4.61	12.7	6.3	35	19	3/4	60	0.452	1.381	3.742	5.81	22.89	4.92	1.98	1.75	36.62	8.15	2.46	4.49	9.15	3.7	1.24	2.47		
L 2 1/2 x 0.212	5.14	12.7	6.3	35	19.0	3/4	60	0.647	1.950	3.759	6.55	25.36	5.56	1.97	1.79	40.44	9.01	2.48	4.49	10.29	4.07	1.25	2.53		
L 2 1/2 x 0.230	5.56	14.3	6.3	35	19.0	3/4	60	0.825	2.463	3.768	7.08	27.23	5.99	1.96	1.80	43.39	9.66	2.48	4.49	11.07	4.34	1.25	2.55		
L 2 1/2 x 0.250	6.01	14.3	6.3	35	19.0	3/4	60	1.057	3.123	3.780	7.68	29.14	6.39	1.96	1.83	45.36	10.1	2.43	4.49	11.65	4.58	1.24	2.54		
L 2 1/2 x 0.272	6.51	14.3	6.3	35	19.0	3/4	60	1.358	3.966	3.790	8.30	31.45	6.98	1.95	1.84	50.02	11.14	2.46	4.49	12.88	4.94	1.25	2.60		
L 2 1/2 x 0.312	7.41	15.9	6.3	35	19.0	3/4	60	2.041	5.835	3.812	9.48	35.38	7.87	1.93	1.88	55.35	12.32	2.41	4.49	14.56	5.51	1.24	2.64		
L 2 1/2 x 0.375	8.78	17.5	6.3	35	19.0	3/4	60	3.521	9.729	3.842	11.16	40.79	9.34	1.91	1.93	64.09	14.27	2.38	4.49	17.06	6.29	1.24	2.71		
L 2 1/2 x 0.500	11.39	20.6	6.3	35	19.0	3/4	60	8.238	21.242	3.926	14.52	51.09	11.87	1.88	2.05	79.99	17.82	2.35	4.49	22.18	7.67	1.24	2.89		
L 3 x 0.188	5.53	12.7	7.9	45	22.2	7/8	70	0.544	2.433	4.476	7.03	40.01	7.22	2.39	2.08	64.4	12.0	3.03	5.4	16.12	5.48	1.51	2.94		
L 3 x 0.210	6.16	12.7	7.9	45	22.2	7/8	70	0.757	3.352	4.489	7.84	44.35	8.04	2.38	2.10	70.79	13.14	3.00	5.39	17.91	6.02	1.51	2.97		
L 3 x 0.212	6.21	14.3	7.9	45	22.2	7/8	70	0.779	3.445	4.490	7.92	44.73	8.11	2.38	2.10	71.39	13.25	3.00	5.39	18.06	6.07	1.51	2.98		
L 3 x 0.224	6.55	14.3	7.9	45	22.2	7/8	70	0.918	4.039	4.495	8.35	46.98	8.54	2.37	2.12	74.97	13.91	3.00	5.39	19.00	6.35	1.51	2.99		
L 3 x 0.227	6.64	14.3	7.9	45	22.2	7/8	70	0.955	4.197	4.497	8.45	47.55	8.64	2.37	2.12	75.86	14.08	3.00	5.39	19.23	6.42	1.51	3.00		
L 3 x 0.230	6.72	14.3	7.9	45	22.2	7/8	70	0.993	4.359	4.498	8.56	48.10	8.75	2.37	2.12	76.75	14.24	2.99	5.39	19.46	6.49	1.51	3.00		
L 3 x 0.250	7.28	14.3	7.9	45	22.2	7/8	70	1.274	5.539	4.492	9.29	51.60	9.50	2.36	2.13	78.7	14.6	2.94	5.4	20.39	6.86	1.49	2.97		
L 3 x 0.277	8.03	14.3	7.9	45	22.2	7/8	70	1.728	7.429	4.522	10.23	56.65	10.38	2.35	2.16	90.26	16.75	2.97	5.39	23.04	7.53	1.50	3.06		
L 3 x 0.281	8.14	14.3	7.9	45	22.2	7/8	70	1.804	7.740	4.524	10.37	57.36	10.52	2.35	2.17	91.38	16.96	2.97	5.39	23.34	7.61	1.50	3.07		
L 3 x 0.313	9.01	15.9	7.9	45	22.2	7/8	70	2.486	10.518	4.541	11.48	62.93	11.61	2.34	2.20	100.15	18.59	2.95	5.39	25.72	8.27	1.50	3.11		
L 3 x 0.375	10.72	17.5	7.9	45	22.2	7/8	70	4.253	17.503	4.581	13.61	73.30	13.60	2.31	2.26	112.79	20.96	2.89	5.38	29.55	9.41	1.47	3.14		
L 3 x 0.500	13.99	20.6	7.9	45	22.2	7/8	70	9.972	38.783	4.643	17.74	92.40	17.50	2.29	2.36	142.76	26.53	2.84	5.38	38.29	11.53	1.47	3.32		
L 3 1/2 x 0.250	8.63	14.3	8.3	50	22.2	7/8	70	1.490	8.961	5.240	10.9	83.7	13.01	2.77	2.46	133.5	21.3	3.50	6.3	33.79	9.71	1.76	3.48		
L 3 1/2 x 0.287	9.76	14.3	8.1	51	22.2	7/8	70	2.249	13.336	5.257	12.43	94.59	14.78	2.76	2.49	150.85	24.00	3.48	6.29	38.33	10.88	1.76	3.52		
L 3 1/2 x 0.313	10.71	15.9	8.1	50	22.2	7/8	70	2.912	17.099	5.264	13.5	101.9	16.0	2.74	2.51	162.5	25.9	3.47	6.3	41.41	11.66	1.75	3.55		
L 3 1/2 x 0.344	11.59	15.9	8.1	53	22.2	7/8	70	3.856	22.385	5.286	14.77	110.77	17.46	2.74	2.54	176.39	28.06	3.46	6.29	45.15	12.55	1.75	3.60		
L 3 1/2 x 0.375	12.65	17.5	8.0	54	22.2	7/8	70	4.984	28.595	5.305	16.00	119.46	18.84	2.72	2.57	191.20	30.44	3.47	6.29	50.22	13.87	1.74	3.63		
L 3 1/2 x 0.437	14.52	20.6	8.0	50	22.2	7/8	70	7.852	43.994	5.337	18.5	135.7	21.7	2.71	2.63	215.4	34.3	3.41	6.3	55.99	15.05	1.74	3.72		
L 3 1/2 x 0.500	16																								



APS
ÁNGULO DE LADOS IGUALES
MILÉSIMAS DE PULGADA

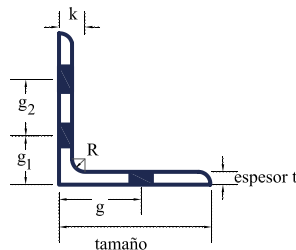

DIMENSIONES

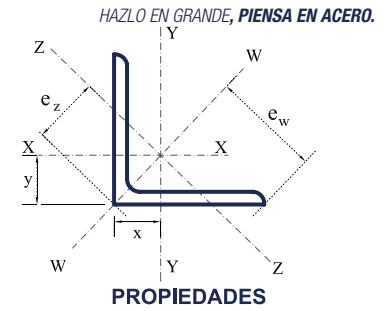

PROPIEDADES

Designación tamaño x espesor		Peso	k	R	Gramil			Propiedades de Torsión				Ejes X - X y Y - Y				Eje W - W				Eje Z - Z				
					g	Diámetro Máximo	Espac. Recom.	J	C _w	r _o	Área	I	S	r	x = y	I	S	r	e _w	I	S	r	e _z	
PERFIL	in x in	kg/m	mm	mm	mm	mm	in	mm	cm ⁴	cm ⁶	cm	cm ²	cm ⁴	cm ³	cm	cm	cm ⁴	cm ³	cm	cm	cm ⁴	cm ³	cm	cm
LI	4 x 0.188	7.42	14.3	9.5	60	22.2	7/8	70	0.729	5.907	5.942	9.45	97.1	13.0	3.20	2.72	155.1	21.6	4.05	7.18	38.99	10.15	2.03	3.84
LI	4 x 0.212	8.36	14.3	9.5	60	22.2	7/8	70	1.044	8.393	5.953	10.65	108.77	14.66	3.20	2.74	173.80	24.19	4.04	7.18	43.74	11.29	2.03	3.88
LI	4 x 0.227	8.94	15.9	9.5	60	22.2	7/8	70	1.280	10.244	5.960	11.38	115.83	15.64	3.19	2.75	185.05	25.76	4.03	7.18	46.62	11.97	2.02	3.89
LI	4 x 0.230	9.05	15.9	9.5	60	22.2	7/8	70	1.331	10.644	5.961	11.53	117.24	15.84	3.19	2.76	187.28	26.07	4.03	7.18	47.19	12.10	2.02	3.90
LI	4 x 0.250	9.82	15.9	9.5	60	22.2	7/8	70	1.707	13.563	5.941	12.5	124.9	17.2	3.18	2.77	191.9	26.7	3.96	7.18	48.10	12.30	2.00	3.91
LI	4 x 0.281	10.98	15.9	9.5	60	22.2	7/8	70	2.420	19.030	5.985	13.99	140.61	19.12	3.17	2.80	224.43	31.24	4.00	7.18	56.78	14.32	2.01	3.97
LI	4 x 0.313	12.20	17.5	9.5	60	22.2	7/8	70	3.337	25.974	6.007	15.48	154.4	21.10	3.15	2.84	239	33.3	3.93	7.18	61.60	15.36	2.00	4.01
LI	4 x 0.344	13.34	17.5	9.5	60	22.2	7/8	70	4.421	34.066	6.016	16.99	168.27	23.06	3.15	2.86	268.26	37.34	3.97	7.18	68.28	16.87	2.00	4.05
LI	4 x 0.375	14.58	19.1	9.5	60	22.2	7/8	70	5.716	43.597	6.032	18.5	181.5	24.9	3.12	2.89	283	39.4	3.91	7.18	73.25	18.17	1.98	4.03
LI	4 x 0.438	16.82	20.6	9.5	60	22.2	7/8	70	9.071	67.760	6.055	21.4	207	28.7	3.12	2.94	323	45.0	3.88	7.18	83.66	20.15	1.98	4.15
LI	4 x 0.500	19.05	22.2	9.5	60	22.2	7/8	70	13.441	98.341	6.084	24.2	231.4	32.3	3.10	2.99	361.3	50.3	3.86	7.18	94.48	22.44	1.98	4.21

- ASTM A36 / A36M $f_y = 2,530 \text{ kg/cm}^2$
- ASTM A529 / A529M G50 $f_y = 3,515 \text{ kg/cm}^2$
- ASTM A572 / A572M G50 $f_y = 3,515 \text{ kg/cm}^2$
- ASTM A572 / A572M G60 $f_y = 4,200 \text{ kg/cm}^2$

Los productos en franja amarilla, son de existencia frecuente.

LM

ÁNGULO DE LADOS IGUALES MILIMÉTRICO

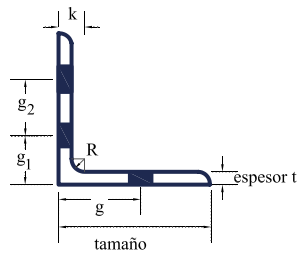

DIMENSIONES

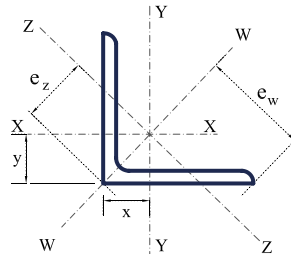

PROPIEDADES

Designación tamaño x espesor	Peso	k	R	Gramil			Sujetadores			Propiedades de Torsión			Ejes X-X y Y-Y				Eje W-W				Eje Z-Z			
				g	Diámetro Máximo	Espac. Recom.	J	C _w	r _o	Área	I	S	r	x=y	I	S	r	e _w	I	S	r	e _z		
PERFIL	in x in	kg/m	mm	mm	mm	mm	in	mm	cm ⁴	cm ⁶	cm	cm ²	cm ⁴	cm ³	cm	cm	cm ⁴	cm ³	cm	cm	cm ⁴	cm ³	cm	cm
LM 25 x 3	1.12	11.1	3.2	14	9.5	3/8	30	0.04	0.02	1.50	1.41	0.82	0.46	0.76	0.74	1.30	0.74	0.96	1.77	0.34	0.32	0.49	1.04	
LM 25 x 4	1.44	11.1	3.2	14	9.5	3/8	30	0.10	0.04	1.52	1.84	1.04	0.60	0.75	0.77	1.63	0.92	0.94	1.77	0.44	0.40	0.49	1.09	
LM 25 x 5	1.77	12.7	3.2	14	9.5	3/8	30	0.19	0.08	1.55	2.25	1.23	0.72	0.74	0.81	1.92	1.09	0.92	1.77	0.53	0.47	0.49	1.14	
LM 25 x 6	2.07	14.3	3.2	14	9.5	3/8	30	0.32	0.13	1.57	2.64	1.40	0.84	0.73	0.84	2.17	1.23	0.91	1.77	0.63	0.53	0.49	1.19	
LM 30 x 3	1.36	11.1	4.7	18	12.7	1/2	40	0.05	0.03	1.79	1.71	1.46	0.68	0.92	0.86	2.32	1.09	1.17	2.12	0.59	0.49	0.59	1.22	
LM 30 x 4	1.76	11.1	4.7	18	12.7	1/2	40	0.12	0.08	1.81	2.24	1.86	0.88	0.91	0.90	2.94	1.39	1.15	2.12	0.77	0.61	0.59	1.27	
LM 30 x 5	2.16	12.7	4.7	18	12.7	1/2	40	0.23	0.14	1.83	2.75	2.22	1.07	0.90	0.93	3.49	1.65	1.13	2.12	0.94	0.71	0.58	1.32	
LM 30 x 6	2.54	14.3	4.7	18	12.7	1/2	40	0.39	0.24	1.85	3.24	2.55	1.25	0.89	0.97	3.99	1.88	1.11	2.12	1.11	0.81	0.58	1.37	
LM 35 x 3	1.60	11.1	4.7	20	12.7	1/2	40	0.06	0.06	2.07	2.01	2.36	0.94	1.08	0.99	3.77	1.52	1.37	2.47	0.96	0.69	0.69	1.39	
LM 35 x 4	2.07	11.1	4.7	20	12.7	1/2	40	0.14	0.13	2.09	2.64	3.03	1.22	1.07	1.02	4.81	1.94	1.35	2.47	1.24	0.86	0.69	1.45	
LM 35 x 5	2.55	12.7	4.7	20	12.7	1/2	40	0.27	0.24	2.12	3.25	3.64	1.49	1.06	1.06	5.76	2.33	1.33	2.47	1.51	1.01	0.68	1.50	
LM 35 x 6	3.01	14.3	4.7	20	12.7	1/2	40	0.46	0.39	2.14	3.84	4.20	1.74	1.05	1.09	6.61	2.67	1.31	2.47	1.78	1.15	0.68	1.55	
LM 40 x 3	1.84	11.1	4.7	20	12.7	1/2	40	0.07	0.09	2.36	2.31	3.58	1.24	1.25	1.11	5.72	2.02	1.57	2.83	1.45	0.92	0.79	1.57	
LM 40 x 4	2.39	11.1	4.7	20	12.7	1/2	40	0.16	0.20	2.38	3.04	4.61	1.62	1.23	1.15	7.34	2.59	1.55	2.83	1.88	1.16	0.79	1.62	
LM 40 x 5	2.94	12.7	4.7	20	12.7	1/2	40	0.31	0.37	2.40	3.75	5.56	1.97	1.22	1.18	8.83	3.12	1.53	2.83	2.29	1.37	0.78	1.67	
LM 40 x 6	3.48	14.3	4.7	20	12.7	1/2	40	0.53	0.61	2.42	4.44	6.45	2.32	1.21	1.22	10.20	3.61	1.52	2.83	2.70	1.57	0.78	1.72	
LM 40 x 7	4.01	14.3	4.7	20	12.7	1/2	40	0.83	0.93	2.45	5.11	7.27	2.65	1.19	1.25	11.45	4.05	1.50	2.83	3.10	1.75	0.78	1.77	
LM 40 x 8	4.52	15.9	4.7	20	12.7	1/2	40	1.23	1.33	2.47	5.76	8.04	2.97	1.18	1.29	12.60	4.45	1.48	2.83	3.49	1.92	0.78	1.82	
LM 45 x 3	2.08	11.1	6.3	25	15.9	5/8	50	0.08	0.12	2.65	2.61	5.16	1.58	1.41	1.24	8.24	2.59	1.78	3.18	2.08	1.19	0.89	1.75	
LM 45 x 4	2.70	11.1	6.3	25	15.9	5/8	50	0.18	0.28	2.67	3.44	6.67	2.07	1.39	1.27	10.62	3.34	1.76	3.18	2.71	1.50	0.89	1.80	
LM 45 x 5	3.34	12.7	6.3	25	15.9	5/8	50	0.35	0.53	2.69	4.25	8.07	2.53	1.38	1.31	12.94	4.03	1.74	3.18	3.31	1.79	0.88	1.85	
LM 45 x 6	3.96	14.3	6.3	25	15.9	5/8	50	0.60	0.89	2.71	5.04	9.39	2.98	1.37	1.34	14.89	4.68	1.72	3.18	3.89	2.05	0.88	1.90	
LM 45 x 7	4.56	14.3	6.3	25	15.9	5/8	50	0.95	1.36	2.73	5.81	10.63	3.41	1.35	1.38	16.80	5.28	1.70	3.18	4.47	2.29	0.88	1.95	
LM 45 x 8	5.15	15.9	6.3	25	15.9	5/8	50	1.40	1.96	2.76	6.56	11.79	3.82	1.34	1.42	18.55	5.83	1.68	3.18	5.03	2.51	0.88	2.00	
LM 50 x 3	2.32	11.1	6.3	30	15.9	5/8	50	0.09	0.17	2.94	2.91	7.15	1.96	1.57	1.36	11.42	3.23	1.98	3.54	2.88	1.50	0.99	1.93	
LM 50 x 4	3.01	11.1	6.3	30	15.9	5/8	50	0.20	0.39	2.95	3.84	9.26	2.57	1.55	1.40	14.77	4.18	1.96	3.54	3.75	1.90	0.99	1.98	
LM 50 x 5	3.73	12.7	6.3	30	15.9	5/8	50	0.40	0.74	2.98	4.75	11.25	3.16	1.54	1.43	17.91	5.07	1.94	3.54	4.59	2.26	0.98	2.03	
LM 50 x 6	4.43	14.3	6.3	30	15.9	5/8	50	0.68	1.25	3.00	5.64	13.13	3.72	1.53	1.47	20.85	5.90	1.92	3.54	5.40	2.60	0.98	2.08	
LM 50 x 7	5.11	15.9	6.3	30	15.9	5/8	50	1.06	1.92	3.02	6.51	14.90	4.26	1.51	1.51	23.59	6.67	1.90	3.54	6.20	2.91	0.98	2.13	
LM 50 x 8	5.78	15.9	6.3	30	15.9	5/8	50	1.57	2.77	3.04	7.36	16.57	4.79	1.50	1.54	26.15	7.40	1.89	3.54	6.98	3.20	0.97	2.18	
LM 50 x 9	6.43	17.5	6.3	30	15.9	5/8	50	2.21	3.81	3.07	8.19	18.14	5.30	1.49	1.58	28.54	8.07	1.87	3.54	7.75	3.48	0.97	2.23	
LM 55 x 4	3.33	11.1	6.3	30	15.9	5/8	50	0.23	0.53	3.24	4.24	12.46	3.13	1.71	1.52	19.88	5.11	2.17	3.89	5.03	2.34	1.09	2.15	
LM 55 x 5	4.12	12.7	6.3	30	15.9	5/8	50	0.44	1.00	3.26	5.25	15.17	3.85	1.70	1.56	24.17	6.22	2.15	3.89	6.17	2.80	1.08	2.21	
LM 55 x 6	4.90	14.3	6.3	30	15.9	5/8	50	0.75	1.69	3.28	6.24	17.74	4.54	1.69	1.60	28.22	7.25	2.13	3.89	7.26	3.22	1.08	2.26	
LM 55 x 7	5.66	15.9	6.3	30	15.9	5/8	50	1.18	2.60	3.30	7.21	20.18	5.22	1.67	1.63	32.02	8.23	2.11	3.89	8.34	3.61	1.08	2.31	
LM 55 x 8	6.40	15.9	6.3	30	15.9	5/8	50	1.74	3.77	3.33	8.16	22.49	5.87	1.66	1.67	35.59	9.15	2.09	3.89	9.39	3.98	1.07	2.36	
LM 55 x 9	7.13	17.5	6.3	30	15.9	5/8	50	2.45	5.22	3.35	9.09	24.68	6.50	1.65	1.70	38.94	10.01	2.07	3.89	10.42	4.33	1.07	2.41	
LM 60 x 4	3.64	11.1	6.3	35	15.9	5/8	50	0.25	0.69	3.53	4.64	16.31	3.75	1.88	1.65	26.05	6.14	2.37	4.24	6.58	2.82	1.19	2.33	
LM 60 x 5	4.51	12.7	6.3	35	15.9	5/8	50	0.48	1.32	3.55	5.75	19.91	4.61	1.86	1.68	31.74	7.48	2.35	4.24	8.07	3.39	1.18	2.38	
LM 60 x 6	5.37	14.3	6.3	35	15.9	5/8	50	0.82	2.22	3.57	6.84	23.33	5.45	1.85	1.72	37.14	8.75	2.33	4.24	9.52	3.91	1.18	2.43	
LM 60 x 7	6.21	15.9	6.3	35	15.9	5/8	50	1.29	3.44	3.59	7.91	26.59	6.27	1.83	1.76	42.25	9.96	2.31	4.24	10.92	4.40	1.18	2.48	
LM 60 x 8	7.03	15.9	6.3	35	15.9	5/8	50	1.91	5.00	3.61	8.96	29.69	7.06	1.82	1.79	47.07	11.09	2.29	4.24	12.30	4.85	1.17	2.54	
LM 60 x 9	7.84	17.5	6.3	35	15.9	5/8	50	2.70	6.92	3.64	9.99	32.64	7.83	1.81	1.83	51.62	12.17	2.27	4.24	13.66	5.28	1.17	2.59	
LM 65 x 4	3.96	11.1	6.3	35	19	3/4	60	0.27	0.89	3.82	5.04	20.90	4.42	2.04	1.77	33.37	7.26	2.57	4.60	8.42	3.36	1.29	2.51	
LM 65 x 5	4.91	12.7	6.3	35	19	3/4	60	0.52	1.70	3.84	6.25	25.55	5.45	2.02	1.81	40.76	8.87	2.55	4.60	10.34	4.04	1.29	2.56	
LM 65 x 6	5.84	14.3	6.3	35	19	3/4	60	0.89	2.86	3.86	7.44	29.99	6.44	2.01	1.85	47.78	10.39	2.53	4.60	12.20	4.67	1.28	2.61	
LM 65 x 7	6.76	15.9	6.3	35	19	3/4	60	1.41	4.43	3.88	8.61	34.23	7.41	1.99	1.88	54.45	11.85	2.51	4.60	14.01	5.26	1.28	2.66	
LM 65 x 8	7.66	15.9	6.3	35	19	3/4	60	2.08	6.46	3.90	9.76	38.29	8.36	1.98	1.92	60.79	13.23	2.50	4.60	15.78	5.82	1.27	2.71	
LM 65 x 9	8.55	17.5	6.3	35	19	3/4	60	2.94	8.97	3.92	10.89	42.16	9.28	1.97	1.95	66.80	14.53	2.48	4.60	17.53	6.34	1.27	2.76	
LM 70 x 5	5.30	12.7	6.3	40	19	3/4	60	0.56	2.14	4.13	6.75	32.16	6.35	2.18	1.94	51.33	10.37	2.76	4.95	12.99	4.75	1.39	2.74	
LM 70 x 6	6.31	14.3	6.3	40	19	3/4	60	0.96	3.61	4.14	8.04	37.81	7.52	2.17	1.97	60.27	12.18	2.74	4.95	15.34	5.50	1.38	2.79	
LM 70 x 7	7.31	14.3	6.3	40	19	3/4	60	1.52	5.60	4.17	9.31	43.22	8.66	2.15	2.01	68.81	13.90	2.72	4.95	17				

LM

ÁNGULO DE LADOS IGUALES MILIMÉTRICO

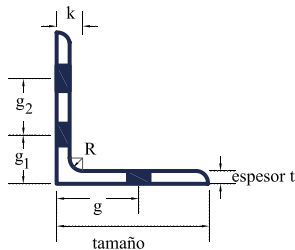

DIMENSIONES

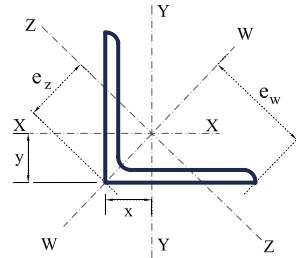

PROPIEDADES

Designación tamaño x espesor		Peso	k	R	Gramil			Sujetadores		Propiedades de Torsión				Ejes X - X' y Y - Y'				Eje W - W				Eje Z - Z			
					g	Diámetro Máximo	Espac. Recom.	J	C _w	r _o	Área	I	S	r	x = y	I	S	r	e _w	I	S	r	e _z		
PERFIL	in x in	kg/m	mm	mm	mm	mm	in	mm	cm ⁴	cm ⁶	cm	cm ²	cm ³	cm ³	cm	cm	cm ⁴	cm ³	cm	cm	cm ⁴	cm ³	cm	cm	
LM	75 x 5	5.69	12.7	7.9	45	22	7/8	70	0.60	2.65	4.41	7.25	39.83	7.32	2.34	2.06	63.59	11.99	2.96	5.30	16.07	5.51	1.49	2.91	
LM	75 x 6	6.78	14.3	7.9	45	22	7/8	70	1.04	4.48	4.43	8.64	46.88	8.68	2.33	2.10	74.78	14.10	2.94	5.30	18.99	6.40	1.48	2.97	
LM	75 x 7	7.86	14.3	7.9	45	22	7/8	70	1.63	6.97	4.45	10.01	53.66	10.00	2.32	2.13	85.49	16.12	2.92	5.30	21.83	7.24	1.48	3.02	
LM	75 x 8	8.92	15.9	7.9	45	22	7/8	70	2.42	10.18	4.47	11.36	60.18	11.29	2.30	2.17	95.75	18.05	2.90	5.30	24.62	8.02	1.47	3.07	
LM	75 x 9	9.96	17.5	7.9	45	22	7/8	70	3.43	14.19	4.49	12.69	66.45	12.55	2.29	2.21	105.55	19.90	2.88	5.30	27.35	8.77	1.47	3.12	
LM	75 x 10	10.99	17.5	7.9	45	22	7/8	70	4.67	19.06	4.52	14.00	72.48	13.78	2.28	2.24	114.92	21.67	2.87	5.30	30.04	9.48	1.46	3.17	
LM	75 x 11	12.00	20.6	7.9	45	22	7/8	70	6.17	24.82	4.54	15.29	78.28	14.99	2.26	2.28	123.86	23.36	2.85	5.30	32.70	10.16	1.46	3.22	
LM	75 x 12	13.00	20.6	7.9	45	22	7/8	70	7.95	31.54	4.56	16.56	83.86	16.16	2.25	2.31	132.40	24.97	2.83	5.30	35.33	10.81	1.46	3.27	
LM	80 x 6	7.25	14.3	7.9	45	22	7/8	70	1.11	5.48	4.72	9.24	57.31	9.92	2.49	2.22	91.45	16.17	3.15	5.66	23.17	7.37	1.58	3.14	
LM	80 x 7	8.41	14.3	7.9	45	22	7/8	70	1.75	8.53	4.74	10.71	65.67	11.44	2.48	2.26	104.68	18.51	3.13	5.66	26.66	8.35	1.58	3.19	
LM	80 x 8	9.54	15.9	7.9	45	22	7/8	70	2.59	12.49	4.76	12.16	73.73	12.92	2.46	2.29	117.38	20.75	3.11	5.66	30.08	9.27	1.57	3.25	
LM	80 x 9	10.67	17.5	7.9	45	22	7/8	70	3.67	17.43	4.78	13.59	81.50	14.38	2.45	2.33	129.57	22.90	3.09	5.66	33.42	10.14	1.57	3.30	
LM	80 x 10	11.77	17.5	7.9	45	22	7/8	70	5.00	23.44	4.80	15.00	88.98	15.80	2.44	2.37	141.25	24.97	3.07	5.66	36.72	10.97	1.56	3.35	
LM	80 x 11	12.86	20.6	7.9	45	22	7/8	70	6.61	30.58	4.83	16.39	96.20	17.19	2.42	2.40	152.44	26.95	3.05	5.66	39.97	11.76	1.56	3.40	
LM	80 x 12	13.94	20.6	7.9	45	22	7/8	70	8.52	38.90	4.85	17.76	103.17	18.55	2.41	2.44	163.16	28.84	3.03	5.66	43.18	12.52	1.56	3.45	
LM	90 x 6	8.19	14.3	7.9	45	22	7/8	70	1.25	7.90	5.30	10.44	82.59	12.65	2.81	2.47	131.86	20.72	3.55	6.36	33.32	9.53	1.79	3.50	
LM	90 x 7	9.51	14.3	7.9	45	22	7/8	70	1.98	12.33	5.31	12.11	94.82	14.61	2.80	2.51	151.26	23.77	3.53	6.36	38.37	10.81	1.78	3.55	
LM	90 x 8	10.80	15.9	7.9	45	22	7/8	70	2.94	18.09	5.33	13.76	106.65	16.52	2.78	2.55	169.98	26.71	3.51	6.36	43.32	12.03	1.77	3.60	
LM	90 x 9	12.08	17.5	7.9	45	22	7/8	70	4.16	25.31	5.36	15.39	118.10	18.40	2.77	2.58	188.03	29.55	3.50	6.36	48.17	13.20	1.77	3.65	
LM	90 x 10	13.34	17.5	7.9	45	22	7/8	70	5.67	34.12	5.38	17.00	129.18	20.24	2.76	2.62	205.42	32.28	3.48	6.36	52.95	14.30	1.76	3.70	
LM	90 x 11	14.59	20.6	7.9	45	22	7/8	70	7.50	44.61	5.40	18.59	139.91	22.04	2.74	2.65	222.17	34.91	3.46	6.36	57.65	15.36	1.76	3.75	
LM	90 x 12	15.82	20.6	7.9	45	22	7/8	70	9.68	56.90	5.42	20.16	150.29	23.82	2.73	2.69	238.29	37.44	3.44	6.36	62.29	16.38	1.76	3.80	
LM	100 x 6	9.14	15.9	9.5	60	22.2	7/8	70	1.40	10.95	5.87	11.64	114.39	15.72	3.13	2.72	182.71	25.84	3.96	7.07	46.07	11.96	1.99	3.85	
LM	100 x 7	10.60	17.5	9.5	60	22.2	7/8	70	2.21	17.12	5.89	13.51	131.53	18.17	3.12	2.76	209.96	29.69	3.94	7.07	53.11	13.61	1.98	3.90	
LM	100 x 8	12.06	19.1	9.5	60	22.2	7/8	70	3.28	25.17	5.91	15.36	148.17	20.57	3.11	2.80	236.34	33.42	3.92	7.07	60.01	15.18	1.98	3.95	
LM	100 x 9	13.49	20.6	9.5	60	22.2	7/8	70	4.64	35.27	5.93	17.19	164.32	22.93	3.09	2.83	261.88	37.03	3.90	7.07	66.77	16.67	1.97	4.01	
LM	100 x 10	14.91	22.2	9.5	60	22.2	7/8	70	6.33	47.63	5.95	19.00	180.00	25.24	3.08	2.87	286.58	40.53	3.88	7.07	73.43	18.10	1.97	4.06	
LM	100 x 11	16.32	25.4	9.5	60	22.2	7/8	70	8.39	62.40	5.97	20.79	195.23	27.51	3.06	2.90	310.48	43.91	3.86	7.07	79.98	19.47	1.96	4.11	
LM	100 x 12	17.71	28.6	9.5	60	22.2	7/8	70	10.83	79.74	5.99	22.56	210.01	29.75	3.05	2.94	333.59	47.18	3.85	7.07	86.44	20.79	1.96	4.16	

ASTM A36 / A36M	f _y = 2,530 kg/cm ²
ASTM A529 / A529M G50	f _y = 3,515 kg/cm ²
ASTM A572 / A572M G50	f _y = 3,515 kg/cm ²
ASTM A572 / A572M G60	f _y = 4,200 kg/cm ²

Los productos en franja amarilla, son de existencia frecuente.

CE

CANAL ESTÁNDAR

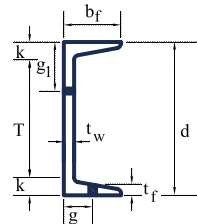

DIMENSIONES

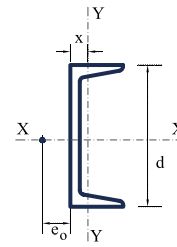

PROPIEDADES

Designación peralte x peso	Peralte		Alma		Patin		Distancia		f _{ts}	h ₀	Gramil		Sujetadores		Área	Distancia			Eje X - X			Eje Y - Y			Propiedades de Torsión			Módulo de Sección Plástico	
	d	t _w	b _f	t _f	T	k	g	g ₁			g	g ₁	Diám. Máx. en Patín	Espac. Recomend.		x	e _o	d / A _v	I	S	r	I	S	r	J	C _w	r _x	r _y	Z _x
PERFIL	mm x kg/m	in x lb/ft	mm	mm	mm	mm	mm	mm	mm	mm	mm	mm	mm	mm	mm	mm	mm	mm	mm	mm	mm	mm	mm	mm	mm	mm	mm	mm	mm
CE ^A 76 x 5.20	3 x 3.5	76.2	3.2	35.8	6.45	42	17	1.16	70	24	38	-	-	-	6.68	10.40	12.52	3.30	62.27	16.31	3.06	7.03	2.87	1.03	0.72	384.61	4.00	20.0	6.00
CE ^A 76 x 6.10	3 x 4.1	76.2	4.3	35.8	6.93	42	17	1.19	69	24	38	-	-	-	7.68	11.07	11.70	3.07	66.60	17.50	2.95	8.32	3.44	1.04	0.98	478.86	3.90	22.0	7.00
CE ^A 76 x 7.44	3 x 5.0	76.2	6.6	37.0	6.90	42	17	1.24	69	24	38	-	-	-	9.42	11.13	9.96	2.98	74.90	19.70	2.82	10.41	3.93	1.04	1.47	697.10	3.70	25.0	8.00
CE ^A 76 x 8.93	3 x 6.0	76.2	9.0	40.0	6.90	42	17	1.32	69	24	38	-	-	-	11.29	11.56	8.18	2.76	87.40	22.90	2.78	12.90	4.42	1.07	2.56	1031.23	3.60	29.0	9.00
CE 102 x 6.7	4 x 4.5	101.6	3.2	40.0	7.52	68	19	1.29	94	25	51	-	-	-	8.90	12.50	14.1	3.38	152.00	30.00	4.14	12.00	4.00	1.20	1.30	1167.10	5.10	35.0	9.00
CE 102 x 8.04	4 x 5.40	101.6	4.6	40.1	7.52	68	19	1.34	94	25	51	-	-	-	10.06	11.61	12.83	3.37	158.20	31.10	3.98	13.32	4.75	1.14	1.44	1520.51	4.80	38.00	9.00
CE 102 x 10.79	4 x 7.25	101.6	6.1	43.7	7.52	68	19	1.43	94	25	51	15.9	5/8	50	13.68	11.66	9.81	3.09	187.30	36.90	3.70	18.31	5.74	1.17	2.92	2752.78	4.40	47.00	11.00
CE 127 x 9.97	5 x 6.70	127.0	4.8	44.5	8.13	89	19	1.48	119	25	64	-	-	-	12.58	12.29	14.00	3.51	308.00	48.50	4.95	19.98	6.23	1.27	2.04	3852.72	5.70	58.00	12.00
CE 127 x 13.39	5 x 9.00	127.0	8.3	47.9	8.13	89	19	1.56	119	29	64	15.9	5/8	50	16.97	12.14	10.85	3.26	366.30	57.70	4.65	26.64	7.37	1.24	3.95	6589.94	5.30	72.00	15.00
CE 152 x 12.20	6 x 8.20	152.4	5.1	48.8	8.70	110	21	1.63	144	29	57	15.9	5/8	50	15.40	12.70	14.80	3.59	535.00	70.40	5.89	27.60	7.82	1.34	2.77	8414.88	6.70	85.00	16.00
CE 152 x 15.63	6 x 10.50	152.4	8.0	51.0	8.70	111	21	1.70	144	29	57	15.9	5/8	50	19.80	12.50	12.00	3.43	621.00	81.70	5.60	34.70	9.01	1.32	4.69	12672.17	6.30	101.00	19.00
CE 152 x 19.35	6 x 13.00	152.4	11.1	54.0	8.70	111	21	1.75	144	35	57	15.9	5/8	50	24.50	12.90	9.32	3.24	711.00	93.60	5.39	42.00	10.20	1.31	8.92	17790.92	6.00	119.00	22.00
CE 178 x 14.58	7 x 9.80	177.8	5.3	53.1	9.30	134	22	1.77	169	32	51	15.9	5/8	50	18.39	12.72	15.45	3.60	878.20	98.80	6.91	40.79	10.32	1.50	3.70	16583.01	7.70	118.00	21.00
CE 178 x 18.23	7 x 12.25	177.8	8.0	51.7	9.30	134	22	1.83	169	32	51	15.9	5/8	50	23.10	13.10	13.30	3.70	1000.00	112.00	6.58	47.00	11.20	1.43	5.62	20333.52	7.30	139.00	23.00
CE 178 x 21.95	7 x 14.75	177.8	10.6	58.4	9.30	134	22	1.87	169	32	51	15.9	5/8	50	27.87	13.52	11.21	3.27	1127.90	126.90	6.38	58.27	12.95	1.45	9.90	32509.26	7.00	160.00	27.00
CE 203 x 17.11	8 x 11.50	203.2	5.6	57.4	9.91	155	24	1.92	193	35	57	19	3/4	60	21.68	14.50	17.69	3.57	1344.40	132.30	7.87	54.11	12.95	1.60	4.85	30277.69	8.70	158.00	26.00
CE 203 x 20.46	8 x 13.75	203.2	7.7	59.5	9.91	155	24	1.97	193	35	57	19	3/4	60	25.94	14.05	15.35	3.45	1409.10	146.60	7.59	62.43	14.09	1.57	6.80	40793.86	8.30	180.00	28.00
CE 203 x 27.90	8 x 18.75	203.2	12.4	64.2	9.91	155	24	2.03	193	38	57	19	3/4	60	35.42	14.35	10.94	3.19	1818.90	179.00	7.16	83.25	16.39	1.52	16.36	65370.82	7.70	228.00	36.00
CE 229 x 19.80	9 x 13.40	228.6	5.9	62.0	10.50	181	24	2.07	218	30	57	19	3/4	60	25.30	15.27	18.95	3.51	1970.00	172.00	8.83	70.80	15.10	1.67	6.29	53015.07	9.60	206.00	32.00
CE 229 x 22.32	9 x 15.00	228.6	7.2	63.0	10.50	181	24	2.10	218	30	57	19	3/4	60	28.20	14.88	17.26	3.46	2090.00	183.00	8.61	76.40	15.70	1.65	7.62	62964.06	9.40	223.00	33.00
CE 229 x 29.76	9 x 20.00	228.6	11.4	67.0	10.50	181	24	2.16	218	30	57	19	3/4	60	37.30	14.81	12.95	3.25	2460.00	216.00	8.13	92.30	17.40	1.57	15.94	96746.63	8.80	277.00	40.00
CE 254 x 22.76	10 x 15.30	254	6.1	66.0	11.07	204	25	2.20	243	38	57	19	3/4	60	28.97	16.10	20.21	3.47	2805.40	221.20	9.83	94.90	19.01	1.81	7.81	85052.44	10.60	261.00	38.00
CE 254 x 29.76	10 x 20.00	254	9.6	69.6	11.07	204	25	2.27	243	40	57	19	3/4	60	37.94	15.40	16.18	3.30	3284.10	258.90	9.30	116.96	21.63	1.76	13.52	129312.30	10.00	318.00	44.00
CE 254 x 37.20	10 x 25.00	254	13.4	73.3	11.07	204	25	2.31	243	40	57	19	3/4	60	47.42	15.67	12.54	3.13	3796.00	298.20	8.94	139.85	24.25	1.72	25.94	177952.94	9.60	379.00	52.00
CE 254 x 44.64	10 x 30.00	254	17.1	77.0	11.07	204	25	2.35	243	40	57	19	3/4	60	56.90	16.48	9.36	2.98	4287.20	339.20	8.69	163.99	27.04	1.70	47.39	229875.71	9.20	438.00	62.00
CE 305 x 30.80	12 x 20.70	304.8	7.2	74.7	12.72	247	29	2.50	292	50	64	22.2	7/8	70	39.29	17.73	22.10	3.21	5369.40	352.30	11.71	161.50	28.35	2.03	13.83	216314.28	12.50	420.00	57.00
CE 305 x 37.20	12 x 25.00	304.8	9.8	77.4	12.72	247	29	2.54	292	50	64	22.2	7/8	70	47.42	17.11	18.94	3.10	5993.70	394.90	11.25	186.05	30.81	1.98	19.87	288307.51	12.00	482.00	63.00
CE 305 x 44.64	12 x 30.00	304.8	13.0	80.5	12.72	247	29	2.57	292	50	64	22.2	7/8	70	56.90	17.11	15.70	2.98	6742.90	442.40	10.89	213.94	33.76	1.94	32.19	374337.89	11.50	554.00	71.00
CE 381 x 50.30	15 x 33.90	381	10.2	86.0	16.50	308	37	2.87	365	50	76	25.4	1.0	80	64.00	20.00	22.53	2.68	13000.00	683.00	14.30	326.00	48.80	2.26	38.65	746800.52	15.10	832.00	101.00
CE 381 x 59.10	15 x 40.00	381	13.2	89.0	16.50	308	37	2.92	365	50	76	25.4	1.0	80	75.30	19.74	19.32	2.59	14300.00	751.00	13.80	364.00	51.80	2.20	54.60	951385.95	14.50	942.00	112.00
CE 381 x 74.41	15 x 50.00	381	18.2	94.0	16.50	308	37	2.97	365	50	76	25.4	1.0	80	93.70	20.27	14.62	2.46	16400.00	863.00	13.20	424.00	56.60	2.13	101.40	1307267.05	13.90	1123.00	133.00

ASTM A36 / A36M	f _y = 2,530 kg/cm ²
ASTM A529 / A529M G50	f _y = 3,515 kg/cm ²
ASTM A572 / A572M G50	f _y = 3,515 kg/cm ²
ASTM A572 / A572M G60	f _y = 4,200 kg/cm ²

Los productos en franja amarilla, son de existencia frecuente.

* Redondeado al milímetro.

^ Sólo se fabrica en ésta calidad.



IR

PERFIL I RECTANGULAR

HAZLO EN GRANDE, PIENSA EN ACERO.

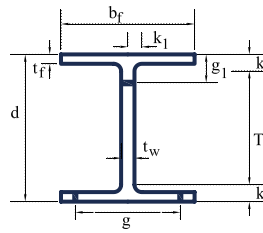

DIMENSIONES

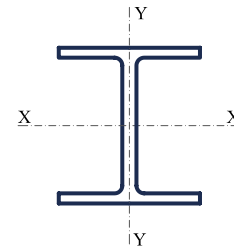

PROPIEDADES

perfil	Designación	Peralte x peso	W/H	DIMENSIONES										PROPIEDADES																				
				Peralte		Alma		Patín		Distancia		Graml		Sujetadores		Área	Criterio de sección compactada		r _y	d / A _y	EJE X - X			EJE Y - Y			Constantes de Torsión		Módulo de Sección Plástico					
				d	tw	bf	tf	T	K	K ₁	g	g ₁	Diámetro Max. en patín	b/f	2t/f		d/t _w	I			S	r	I	S	r	J	C _w	Z _x	Z _y					
mm* x kg/m	in x lb/ft	mm	mm	mm	mm	mm	mm	mm	mm	mm	mm	mm	mm	mm	mm	mm	mm	mm	mm	mm	mm	mm	mm	mm	mm	mm	mm	mm	mm	mm	mm	mm	mm	mm
IR	102 x 194	4 x 13	H	106	7.1	103	8.8	71	17	11	60	50	12.7	1/2	24.7	5.9	14.9	2.8	1.17	470	89	4.4	161	31	2.5	6.2	3802.76	103	48					
IR	127 x 23.70	5 x 16	H	127	6.1	127	9.1	89	19	11	70	50	19.0	3/4	23.7	6.9	20.8	3.5	1.1	1087	140	5.4	313	49	3.2	7.9	10877.07	157	75					
IR	127 x 28.1	5 x 19	H	131	6.9	128	10.9	90	21	11	70	55	22.2	7/8	28.1	5.9	19.0	3.5	0.94	1091	167	5.5	380	60	3.3	12.9	13702.81	190	91					
IR	152 x 12.7	6 x 8.5	W	148	4.3	100	4.90	122.99	12.54	9.8	60	45	12.7	1/2	16.3	10.2	34.3	2.6	3.00	620	84	6.2	82	17	2.2	1.4	4222.30	93	25					
IR	152 x 13.6	6 x 9	W	150	4.3	100	5.5	121	14	10	60	45	12.7	1/2	17.3	9.1	34.9	2.6	2.74	683	91	6.3	91	18	2.3	1.7	4750.26	102	28					
IR	152 x 18.0	6 x 12	W	153	5.8	102	7.1	121	16	10	60	55	12.7	1/2	22.9	7.2	26.4	2.7	2.12	920	120	6.3	124	25	2.3	3.7	6598.91	136	58					
IR	152 x 24.0	6 x 16	W	160	6.6	102	10.3	121	19	11	60	55	12.7	1/2	30.6	5.0	24.2	2.7	1.51	1336	167	6.6	164	36	2.5	9.2	10308.64	192	56					
IR	152 x 22.4	6 x 15	H	152	5.8	152	6.6	120	16	10	90	55	22.2	7/8	26.6	11.5	26.2	4.1	1.51	1211	159	6.5	388	51	3.7	4.2	20506.93	177	78					
IR	152 x 23.7	6 x 20	H	157	6.6	153	9.3	119	19	11	90	55	22.2	7/8	37.9	8.2	23.8	4.2	1.11	1723	220	6.8	554	72	3.8	9.9	30214.16	244	110					
IR	152 x 37.2	6 x 25	H	162	8.1	154	11.6	121	21	11	90	60	25.4	1	47.4	6.6	20.0	4.2	0.91	2223	274	6.9	712	92	3.9	19.1	40263.88	310	140					
IR	203 x 15.0	8 x 10	W	200	4.3	100	5.2	169	16	11	60	55	12.7	1/2	19.1	9.6	46.5	2.5	3.85	1282	128	8.2	87	17	2.1	1.7	8253.48	145	27					
IR	203 x 19.4	8 x 13	W	203	5.8	102	6.5	168	17	11	60	55	12.7	1/2	24.8	7.8	35.0	2.6	3.08	1648	162	8.2	114	22	2.1	3.7	11004.49	187	35					
IR	203 x 22.5	8 x 15	W	206	6.2	102	8.0	168	19	13	60	55	12.7	1/2	26.6	6.4	33.2	2.6	2.52	1998	193	8.4	142	28	2.2	5.8	13917.42	223	44					
IR	203 x 26.6	8 x 18	W	207	5.8	133	8.4	169	19	13	70	55	22.2	7/8	33.9	7.9	35.7	3.5	1.85	2576	249	8.7	332	50	3.1	7.1	32736.83	279	76					
IR	203 x 31.2	8 x 21	W	210	6.4	134	10.2	169	21	13	70	60	25.4	1	39.7	6.6	32.8	3.6	1.55	3134	298	8.9	407	61	3.2	11.7	40816.64	334	93					
IR	203 x 35.9	8 x 24	W	201	6.2	165	10.2	157	22	14	90	60	25.4	1	45.7	8.1	32.4	4.5	1.2	3446	342	8.7	762	92	4.1	14.6	69350.84	380	140					
IR	203 x 41.8	8 x 28	W	205	7.2	166	11.8	157	24	14	90	60	25.4	1	53.2	7.0	28.5	4.5	1.04	4079	398	8.8	903	109	4.1	22.5	84263.99	446	166					
IR	203 x 46.2	8 x 31	H	203	7.2	203	11	156	24	14	140	60	22.2	7/8	56.9	9.2	28.2	5.5	0.91	4579	451	8.8	1544	152	5.1	22.5	142296.04	498	231					
IR	203 x 52.2	8 x 35	H	206	7.9	204	12.6	155	25	14	140	60	25.4	1	65.5	8.1	26.1	5.6	0.81	5286	511	8.9	1773	174	5.2	32.0	165791.28	569	284					
IR	203 x 59.3	8 x 40	H	210	9.1	205	14.2	156	27	16	140	65	25.4	1	75.5	7.2	23.1	5.6	0.72	6077	582	9	2044	200	5.2	46.6	195905.34	652	303					
IR	203 x 71.4	8 x 48	H	216	10.2	206	17.4	156	30	16	140	65	25.4	1	91.0	5.9	21.2	5.7	0.6	7659	710	9.2	2535	246	5.3	81.6	249963.42	803	375					
IR	203 x 86.6	8 x 56	H	222	13.0	209	20.6	156	33	17	140	70	25.4	1	110.3	5.1	17.1	5.7	0.52	9490	852	9.3	3126	300	5.3	139.0	316991.72	980	457					
IR	203 x 99.8	8 x 67	H	229	14.5	210	23.7	156	37	17	140	75	25.4	1	127.1	4.4	15.8	5.8	0.46	11321	990	9.4	3688	351	5.4	213.0	388605.4	1150	536					
IR	254 x 17.9	10 x 12	W	251	4.8	101	5.3	219	16	11	60	65	12.7	1/2	22.8	9.5	52.3	2.4	4.67	2239	179	9.9	91	18	2	2.5	13733.83	206	29					
IR	254 x 22.3	10 x 15	W	254	5.8	102	6.9	219	17	11	60	65	12.7	1/2	28.5	7.4	43.8	2.5	3.64	2686	226	10	120	24	2.1	4.2	18317.52	262	38					
IR	254 x 25.3	10 x 17	W	257	6.1	102	8.4	219	19	13	60	65	12.7	1/2	32.2	6.1	42.1	2.6	3.01	3409	265	10.3	148	29	2.1	6.7	22866.73	306	46					
IR	254 x 28.5	10 x 19	W	260	6.4	102	10	219	21	13	60	70	12.7	1/2	36.3	5.1	40.6	2.6	2.54	4008	308	10.5	176	35	2.2	9.6	27500.00	354	55					
IR	254 x 32.9	10 x 22	W	258	6.1	146	9.1	220	19	13	90	65	19.0	3/4	41.9	8.0	42.3	3.8	1.93	4912	380	10.8	475	65	3.4	10.0	73567.06	426	100					
IR	254 x 38.5	10 x 26	W	262	6.6	147	11.2	218	22	13	90	70	19.0	3/4	49.1	6.6	39.7	3.9	1.6	5994	457	11	587	80	3.5	16.6	92306.69	513	123					
IR	254 x 44.8	10 x 30	W	266	7.6	148	13	218	24	13	90	70	22.2	7/8	57.0	5.7	35.0	3.9	1.39	7076	531	11.1	695	94	3.5	25.8	111215.64	600	145					
IR	254 x 49.2	10 x 33	W	247	7.4	202	11	193	27	17	140	65	22.2	7/8	62.6	9.2	33.4	5.4	1.11	7076	574	10.6	1523	151	4.9	24.1	212062.52	636	229					
IR	254 x 58.2	10 x 39	W	252	8.0	203	13.5	195	29	17	140	75	22.2	7/8	74.2	7.5	31.5	5.5	0.93	8699	690	10.8	1873	185	5	40.8	266351.14	767	282					
IR	254 x 67.4	10 x 45	W	257	8.9	202	16	193	32	17	140	80	25.4	1	85.8	6.3	28.9	5.5	0.8	10323	805	11	2223	218	5.1	62.9	322785.16	900	333					
IR	254 x 72.9	10 x 49	H	253	8.6	254	14.2	193	30	17	140	75	28.6	1 1/8	92.9	8.9	29.4	7	0.7	11321	895	11	3888	306	6.5	57.9	554287.28	990	464					
IR	254 x 80.0	10 x 54	H	256	9.4	255	15.6	193	32	17	140	80	28.6	1 1/8	101.9	8.2	27.2	7	0.64	12612	983	11.1	4287	338	6.5	75.8	619387.47	1091	513					
IR	254 x 89.1	10 x 60	H	260	10.7	256	17.3	193	33	19	140	80	28.6	1 1/8	113.6	7.4	24.3	7	0.59	14193	1093	11.2	4828	377	6.5	103.0	710962.71	1222	574					
IR	254 x 101.3	10 x 68	H	264	11.9	257	19.6	194	35	19	140	80	28.6	1 1/8	129.0	6.6	22.2	7.1	0.53	16400	1240	11.3	5577	433	6.6	148.0	832804.49	1398	657					
IR	254 x 114.5	10 x 77	H	269	13.5	259	22.1	193	38	21	140	85	28.6	1 1/8	145.8	5.9	19.9	7.1	0.47	18938	1408	11.4	6410	493	6.6	213.0	976877.75	1600	752					
IR	254 x 131.2	10 x 88	H	275	15.4	261	25.1	193	41	21	140	90	28.6	1 1/8	167.1	5.2	17.9	7.2	0.42	22227	1614	11.5	7451	570	6.7	313.0	1163287.56	1851	870					
IR	254 x 148.9	10 x 100	H	282	17.3	263	28.4	193	44	22	140	90	28.6	1 1/8	189.7	4.6	16.3	7.2	0.38	25931	1835	11.7	8616	655	6.7	454.0	1385301.16	2130	1000					
IR	254 x 166.6	10 x 112	H	289	19.2	265	31.8	193	48	24	140	95	28.6	1 1/8	212.3	4.2	15.1	7.3	0.34	29802	2065	11.8	9823	742	6.8	629.0	1624523.81	2409	1134					
IR	305 x 21.1	12 x 14	W	303	5.0	101	5.7	268	17	13	60	65	12.7	1/2	26.8	8.9	60.6	2.4	0.25	3688	244	11.7	98	20	1.9	2.9	21654.89	285	31					
IR	305 x 23.9	12 x 16	W	305	5.6	101	6.7	266	19	13	60	65	12.7	1/2	30.4	7.5	54.5	2.4	4.46	4287	280	11.9	117	23	2	4.2	26027.50	329	37					
IR	305 x 28.2	12 x 19	W	309	6.0	102	8.9	268	21	13	60	70	12.7	1/2	35.9	5.7	51.5	2.5	2.42	5411	349	12.2	157	31	2.1	7								

IR

PERFIL I RECTANGULAR

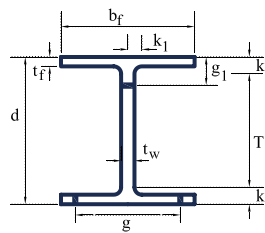

DIMENSIONES

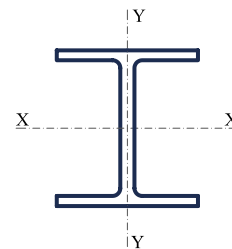

PROPIEDADES

perfil	Designación		W/H	DIMENSIONES										PROPIEDADES														
	Peralte x peso			d	Alma	Patin		Distancia		Gramm		Sujetadores		Área	Criterio de sección compactada		EJE X - X		EJE Y - Y		Constantes de Torsión		Módulo de Sección Plástico					
	mm² x kg/m	in x lb/ft				bf	tf	T	K	K _t	g	g ₁	mm		in	cm²	b _f /2t _f	d/t _w	r _t	d/A _c	I	S	r	I	S	r	J	C _w
IR 305 x 96.7	12 x 65	H	308	9.9	305	15.4	241	33	21	140	80	28.6	1.18	123.2	9.9	31.1	8.3	0.66	22185	1440	13.4	7242	477	7.7	90.7	1550055.23	1586	723

- ASTM A992 $f_y = 3,515 \text{ kg/cm}^2$
- ASTM A572 / A572M G50 $f_y = 3,515 \text{ kg/cm}^2$
- ASTM A529 / A529M G50 $f_y = 3,515 \text{ kg/cm}^2$
- ASTM A572 / A572M G60 $f_y = 4,200 \text{ kg/cm}^2$
- ASTM A709 / A709M G50 $f_y = 3,515 \text{ kg/cm}^2$
- CSA G40-20 / G40-21

Los productos en franja amarilla, son de existencia frecuente.
 * Redondeado al milímetro.



IR

PERFIL I
RECTANGULAR

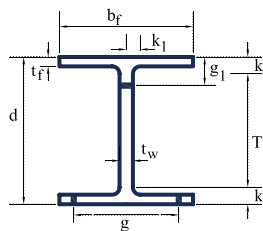

DIMENSIONES

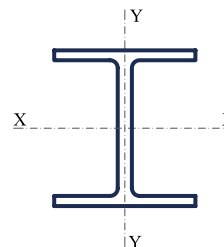

PROPIEDADES

perfil	DIMENSIONES											PROPIEDADES																	
	Designación		W/H	Peralte		Alma		Patin		Distancia		Graml		Sujetadores		Área	Criterio de sección compactada	r _f	d / A _v	EJE X - X			EJE Y - Y			Constantes de Torsión		Módulo de Sección Plástico	
	Peralte x peso			d	tw	bf	tf	T	K	K ₁	g	g ₁	Díametro Max. en patin	cm ²	bf/ 2tf					d/t _w	I	S	r	I	S	r	J	C _w	Z _x
mm ² x kg/m	in x lb/ft	mm	mm	mm	mm	mm	mm	mm	mm	mm	mm	mm	in	cm ²			cm ⁴	cm ³	cm	cm ⁴	cm ³	cm	cm ⁴	cm ⁶	cm ³	cm ³			
IR	533 x 92,7	21 x 62	W	533	10,2	209	15,6	463	35	22	140	80	25,4	1	118,1	6,7	52,3	5,3	1,63	55359	2081	21,7	2393	228	4,5	76,2	1601531,76	2360	356
IR	533 x 101,3	21 x 68	W	537	10,9	210	17,7	464	37	22	140	85	25,4	1	129,0	5,9	49,3	5,4	1,47	61602	2294	21,8	2693	257	4,6	102,0	1915570,04	2622	400
IR	533 x 108,9	21 x 73	W	539	11,6	211	18,8	463	38	24	140	85	25,4	1	138,7	5,6	46,5	5,4	1,36	66597	2474	21,9	2939	279	4,6	126,0	1986292,57	2919	436
IR	533 x 123,1	21 x 83	W	544	13,1	212	21,2	465	40	24	140	85	25,4	1	156,8	5,0	41,5	5,5	1,21	76170	2802	22,0	3388	320	4,6	161,0	2310519,04	3212	500
IR	533 x 138,3	21 x 93	W	549	14,7	214	23,6	463	43	25	140	90	25,4	1	176,1	4,5	37,3	5,5	1,09	86160	3146	22,1	3857	362	4,7	251,0	2686666,58	3622	569
IR	533 x 150,9	21 x 101	W	543	12,7	312	20,3	463	40	24	140	85	28,6	1/8	192,3	7,7	42,8	8,3	0,86	100728	3720	22,9	10323	660	7,3	217,0	7051003,60	4146	1011
IR	533 x 165,6	21 x 111	W	546	14,0	313	22,2	464	41	24	140	90	28,6	1/8	211,0	7,0	39,0	8,3	0,78	111133	4080	23,0	11405	729	7,4	284,0	7822873,12	4572	1118
IR	533 x 181,8	21 x 122	W	551	15,2	315	24,4	465	43	25	140	90	28,6	1/8	231,6	6,5	36,3	8,4	0,72	123204	4474	23,1	12695	806	7,4	374,0	8801048,69	5031	1239
IR	533 x 196,5	21 x 132	W	554	16,5	316	26,3	462	46	25	140	95	28,6	1/8	250,3	6,0	33,6	8,4	0,67	134026	4834	23,2	13860	877	7,4	470,0	9648891,60	5437	1349
IR	533 x 218,8	21 x 147	W	560	18,3	318	29,2	465	48	27	140	95	28,6	1/8	278,7	5,4	30,6	8,5	0,6	151091	5391	23,3	15650	985	7,5	640,0	11023415,54	6112	1517
IR	610 x 82,0	24 x 55	W	599	10,0	178	12,8	532	33	24	90	80	28,6	1/8	104,5	7,0	59,9	4,3	2,62	56191	1868	23,1	1211	136	3,4	49,0	1040341,16	2196	218
IR	610 x 92,2	24 x 62	W	603	10,9	179	15,0	533	35	27	90	80	28,6	1/8	117,4	6,0	55,3	4,3	2,25	64516	2147	23,4	1436	161	3,5	71,0	1241220,96	2507	237
IR	610 x 101,6	24 x 68	W	603	10,5	228	14,9	533	35	24	140	80	28,6	1/8	129,7	7,7	57,4	5,7	1,78	76170	2524	24,3	2930	257	4,7	78,0	2533436,29	2900	401
IR	610 x 113,4	24 x 76	W	608	11,2	228	17,3	535	37	24	140	85	28,6	1/8	144,5	6,6	54,3	5,8	1,54	87408	2824	24,6	3434	302	4,9	112,0	2965533,92	3277	469
IR	610 x 125,1	24 x 84	W	612	11,9	229	19,6	533	40	24	140	85	28,6	1/8	159,4	5,8	51,4	5,9	1,37	99647	3212	24,9	3929	342	5,0	154,0	3447086,15	3671	534
IR	610 x 140,3	24 x 94	W	617	13,1	230	22,2	535	41	25	140	90	28,6	1/8	178,7	5,2	47,1	5,9	1,21	112382	3638	25,1	4537	393	5,0	219,0	4012829,50	4162	615
IR	610 x 153,4	24 x 103	W	623	14,0	229	24,9	533	45	25	140	90	28,6	1/8	196,0	4,6	44,5	5,9	1,09	125000	4010	25,3	5000	437	5,1	295,0	4471545,13	4600	682
IR	610 x 155,0	24 x 104	W	611	12,7	324	19,1	535	38	25	140	85	28,6	1/8	167,4	8,5	48,1	8,5	0,99	129031	4228	25,7	10780	667	7,4	196,0	9441814,19	4736	1023
IR	610 x 174,2	24 x 117	W	616	14,0	325	21,6	534	41	25	140	90	28,6	1/8	221,9	7,5	44,0	8,6	0,87	147345	4769	25,7	12362	762	7,5	280,0	10919087,58	5359	1170
IR	610 x 195,0	24 x 131	W	622	15,4	327	24,4	533	44	27	140	90	28,6	1/8	248,4	6,7	40,4	8,6	0,78	167324	5391	25,9	14152	869	7,5	365,0	12635108,39	6063	1336
IR	610 x 217,8	24 x 146	W	628	16,5	328	27,7	533	48	27	140	95	28,6	1/8	277,4	5,9	38,1	8,7	0,69	190633	6080	26,2	16272	991	7,6	558,0	14659448,46	6850	1527
IR	610 x 241,6	24 x 162	W	635	17,9	329	31,1	533	51	27	140	100	28,6	1/8	307,8	5,3	35,5	8,8	0,62	215191	6784	26,4	18439	1121	7,7	770,0	16811537,44	7669	1721
IR	686 x 125,6	27 x 84	W	678	11,7	253	16,3	609	35	24	140	80	28,6	1/8	160,0	7,8	57,9	6,3	1,65	118626	3490	27,2	4412	347	5,3	117,0	4829451,20	3998	544
IR	686 x 140,3	27 x 94	W	684	12,4	254	18,9	611	37	24	140	85	28,6	1/8	178,7	6,7	55,2	6,4	1,42	136107	3982	27,7	5161	406	5,4	168,0	5707524,22	4556	636
IR	686 x 151,9	27 x 102	W	688	13,1	254	21,1	609	40	24	140	85	28,6	1/8	193,6	6,0	52,5	6,5	1,28	150675	4375	27,9	5786	456	5,5	220,0	6433389,90	4998	711
IR	686 x 169,7	27 x 114	W	693	14,5	256	23,6	611	41	24	140	90	28,6	1/8	216,1	5,4	47,8	6,6	1,15	170238	4900	28,0	6618	516	5,5	305,0	7413754,28	5621	808
IR	686 x 192,0	27 x 129	W	702	15,5	254	27,9	610	46	23	140	90	28,6	1/8	244,0	4,6	45,3	6,6	0,99	198000	5640	28,5	7640	602	5,6	462,0	8679246,47	6460	941
IR	686 x 217,3	27 x 146	W	695	15,4	355	24,8	610	43	25	140	90	28,6	1/8	276,8	7,2	45,1	9,3	0,79	234337	6735	29,0	18439	1041	8,2	454,0	20705523,72	7554	1598
IR	686 x 240,1	27 x 161	W	701	16,8	356	27,4	609	46	25	140	95	28,6	1/8	305,8	6,5	41,7	9,4	0,72	261392	7456	29,2	20687	1162	8,2	612,0	23486141,23	8390	1786
IR	686 x 264,9	27 x 178	W	706	18,4	358	30,2	611	48	27	140	95	28,6	1/8	387,4	5,9	38,4	9,4	0,65	290945	8226	29,5	23100	1291	8,3	812,0	26374750,71	9291	2000
IR	762 x 134,0	30 x 90	W	750	11,9	264	15,5	680	35	25	140	85	28,6	1/8	170,0	8,5	63,0	6,5024	1,83	150000	4000	29,7	4770	361	5,3	118,0	6433421,23	4630	568
IR	762 x 147,4	30 x 99	W	753	13,2	265	17,0	680	37	25	140	85	28,6	1/8	187,8	7,8	57,0	6,5	1,67	166076	4408	29,7	5328	401	5,3	157,0	7215390,72	5113	633
IR	762 x 160,5	30 x 108	W	758	13,8	266	19,3	678	40	25	140	85	28,6	1/8	204,5	6,9	54,9	6,6	1,48	186055	4900	30,2	6077	457	5,5	208,0	8290208,31	5670	719
IR	762 x 173,2	30 x 116	W	762	14,4	267	21,6	680	41	25	140	90	28,6	1/8	220,7	6,2	52,9	6,7	1,32	205201	5391	30,5	6826	513	5,6	268,0	9354899,21	6194	806
IR	762 x 184,9	30 x 124	W	766	14,9	267	21,6	681	43	25	140	90	28,6	1/8	235,5	6,2	51,4	6,8	1,21	223100	5817	30,7	7534	564	5,7	333,0	10437064,17	6686	885
IR	762 x 197,0	30 x 132	W	770	15,6	268	25,4	681	44	27	140	90	28,6	1/8	251,0	5,3	49,4	6,8	1,13	240165	6227	31,0	8158	610	5,7	405,0	11307582,72	7161	957
IR	762 x 220,0	30 x 148	W	779	16,5	266	30,0	680	50	25	140	90	28,6	1/8	278,0	4,4	47,2	6,8	0,98	278000	7140	31,6	9440	710	5,8	605,0	1323923,60	8190	1110
IR	838 x 175,7	33 x 118	W	835	14,0	292	18,8	755	40	27	140	85	28,6	1/8	223,9	7,8	59,6	7,2	1,52	245576	5883	33,0	7784	534	5,9	221,0	12963910,28	6801	841
IR	838 x 194,0	33 x 130	W	840	14,7	292	21,7	755	43	27	140	90	28,6	1/8	247,1	6,7	57,1	7,3	1,32	279290	6653	33,5	9074	621	6,1	307,0	15190213,78	7653	975
IR	838 x 210,7	33 x 141	W	846	14,4	293	24,4	757	44	27	140	90	28,6	1/8	268,4	6,0	58,8	7,4	1,18	310091	7341	34,0	10240	700	6,2	404,0	17806719,94	8423	1096
IR	838 x 226,4	33 x 152	W	851	16,1	294	26,8	755	48	29	140	95	28,6	1/8	288,4	5,5	52,9	7,5	1,08	339644	7980	34,3	11363	773	6,3	516,0	19293734,97	9160	1211
IR	838 x 251,0	33 x 169	W	859	17,0	292	31,0	755	52	27	140	95																	

SOL

SOLERA

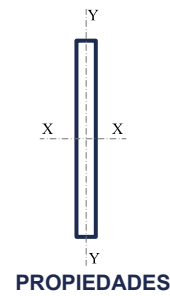
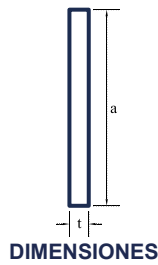

Designación	Peso						Área	Eje X - X			Eje Y - Y				
	**a	x	t					I	S	r	I	S	r		
PERFIL	mm	x	mm	in	x	in	kg/m	lb/ft	cm ²	cm ⁴	cm ³	cm	cm ⁴	cm ³	cm
SOL	25	x	3	1	x	1/8	0.63	0.43	0.81	0.43	0.34	0.73	0.01	0.01	0.09
SOL	25	x	5	1	x	3/16	0.95	0.64	1.21	0.65	0.51	0.73	0.02	0.02	0.14
SOL	25	x	6	1	x	1/4	1.27	0.85	1.61	0.87	0.68	0.73	0.05	0.04	0.18
SOL	25	x	8	1	x	5/16	1.58	1.06	2.02	1.08	0.85	0.73	0.11	0.08	0.23
SOL	25	x	10	1	x	3/8	1.90	1.28	2.42	1.30	1.02	0.73	0.18	0.14	0.27
SOL	25	x	13	1	x	1/2	2.53	1.70	3.23	1.73	1.37	0.73	0.43	0.34	0.37
SOL	32	x	3	1 1/4	x	1/8	0.79	0.53	1.01	0.85	0.53	0.92	0.01	0.01	0.09
SOL	32	x	5	1 1/4	x	3/16	1.19	0.80	1.51	1.27	0.80	0.92	0.03	0.02	0.14
SOL	32	x	6	1 1/4	x	1/4	1.58	1.06	2.02	1.69	1.07	0.92	0.07	0.04	0.18
SOL	32	x	8	1 1/4	x	5/16	1.97	1.33	2.52	2.12	1.33	0.92	0.13	0.08	0.23
SOL	32	x	10	1 1/4	x	3/8	2.37	1.60	3.02	2.54	1.60	0.92	0.23	0.14	0.27
SOL	32	x	13	1 1/4	x	1/2	3.16	2.13	4.03	3.39	2.13	0.92	0.54	0.34	0.37
SOL	32	x	16	1 1/4	x	5/8	3.96	2.66	5.04	4.23	2.67	0.92	1.06	0.67	0.46
SOL	32	x	19	1 1/4	x	3/4	4.75	3.19	6.05	5.08	3.20	0.92	1.83	1.15	0.55
SOL	32	x	25	1 1/4	x	1	6.33	4.25	8.06	6.77	4.27	0.92	4.34	2.73	0.73
SOL	38	x	5	1 1/2	x	3/16	1.42	0.96	1.81	2.20	1.15	1.10	0.03	0.02	0.14
SOL	38	x	6	1 1/2	x	1/4	1.90	1.28	2.42	2.93	1.54	1.10	0.08	0.04	0.18
SOL	38	x	8	1 1/2	x	5/16	2.37	1.59	3.02	3.66	1.92	1.10	0.16	0.08	0.23
SOL	38	x	10	1 1/2	x	3/8	2.85	1.91	3.63	4.39	2.30	1.10	0.27	0.14	0.27
SOL	38	x	13	1 1/2	x	1/2	3.80	2.55	4.84	5.85	3.07	1.10	0.65	0.34	0.37
SOL	38	x	16	1 1/2	x	5/8	4.75	3.19	6.05	7.32	3.84	1.10	1.27	0.67	0.46
SOL	38	x	19	1 1/2	x	3/4	5.70	3.83	7.26	8.78	4.61	1.10	2.20	1.15	0.55
SOL	38	x	25	1 1/2	x	1	7.60	5.10	9.68	11.71	6.15	1.10	5.20	2.73	0.73
SOL	44	x	5	1 3/4	x	3/16	1.66	1.12	2.12	3.49	1.57	1.28	0.04	0.02	0.14
SOL	44	x	6	1 3/4	x	1/4	2.22	1.49	2.82	4.65	2.09	1.28	0.09	0.04	0.18
SOL	44	x	8	1 3/4	x	5/16	2.76	1.86	3.53	5.81	2.61	1.28	0.19	0.08	0.23
SOL	44	x	10	1 3/4	x	3/8	3.32	2.23	4.23	6.97	3.14	1.28	0.32	0.14	0.27
SOL	44	x	13	1 3/4	x	1/2	4.43	2.98	5.65	9.29	4.18	1.28	0.76	0.34	0.37
SOL	44	x	16	1 3/4	x	5/8	5.54	3.72	7.06	11.62	5.23	1.28	1.48	0.67	0.46
SOL	44	x	19	1 3/4	x	3/4	6.65	4.47	8.47	13.94	6.27	1.28	2.56	1.15	0.55
SOL	44	x	25	1 3/4	x	1	8.86	5.95	11.29	18.59	8.36	1.28	6.07	2.73	0.73
SOL	51	x	5	2	x	3/16	1.90	1.28	2.42	5.20	2.05	1.47	0.05	0.02	0.14
SOL	51	x	6	2	x	1/4	2.53	1.70	3.23	6.94	2.73	1.47	0.11	0.04	0.18
SOL	51	x	8	2	x	5/16	3.16	2.12	4.03	8.67	3.41	1.47	0.21	0.08	0.23
SOL	51	x	10	2	x	3/8	3.80	2.55	4.84	10.41	4.10	1.47	0.37	0.14	0.27
SOL	51	x	13	2	x	1/2	5.06	3.40	6.45	13.87	5.46	1.47	0.87	0.34	0.37
SOL	51	x	16	2	x	5/8	6.33	4.25	8.06	17.34	6.83	1.47	1.69	0.67	0.46
SOL	51	x	19	2	x	3/4	7.60	5.10	9.68	20.81	8.19	1.47	2.93	1.15	0.55
SOL	51	x	25	2	x	1	10.13	6.81	12.90	27.75	10.92	1.47	6.94	2.73	0.73
SOL	51	x	38	2	x	1 1/2	15.19	10.21	19.35	41.62	16.39	1.47	23.41	9.22	1.10
SOL	57	x	6	2 1/4	x	1/4	2.85	1.91	3.63	9.88	3.46	1.65	0.12	0.04	0.18
SOL	57	x	8	2 1/4	x	5/16	3.55	2.39	4.54	12.35	4.32	1.65	0.24	0.08	0.23
SOL	57	x	10	2 1/4	x	3/8	4.27	2.87	5.44	14.82	5.19	1.65	0.41	0.14	0.27
SOL	57	x	13	2 1/4	x	1/2	5.70	3.83	7.26	19.76	6.91	1.65	0.98	0.34	0.37
SOL	57	x	16	2 1/4	x	5/8	7.12	4.79	9.07	24.69	8.64	1.65	1.91	0.67	0.46
SOL	57	x	19	2 1/4	x	3/4	8.55	5.74	10.89	29.63	10.37	1.65	3.29	1.15	0.55
SOL	57	x	25	2 1/4	x	1	11.39	7.66	14.52	39.51	13.83	1.65	7.80	2.73	0.73
SOL	57	x	32	2 1/4	x	1 1/4	14.24	9.57	18.15	49.39	17.28	1.65	15.24	5.33	0.92
SOL	57	x	38	2 1/4	x	1 1/2	17.09	11.48	21.77	59.27	20.74	1.65	26.34	9.22	1.10

Acero ASTM A-36 $f_y = 2530 \text{ kg/cm}^2$
 Acero ASTM A-529 G 50 $f_y = 3515 \text{ kg/cm}^2$
 Acero ASTM A-572 G 50 $f_y = 3515 \text{ kg/cm}^2$
 Acero ASTM A-572 G 60 $f_y = 4200 \text{ kg/cm}^2$

Los productos en franja amarilla, son de existencia frecuente.

* La resistencia es sólo valor de referencia.

** Redondeado al milímetro.



SOL

SOLERA

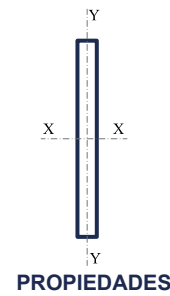
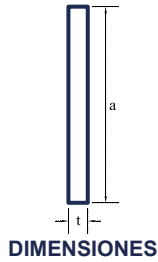

HAZLO EN GRANDE, PIENSA EN ACERO.

PERFIL	Designación						Peso		Área	Eje X - X			Eje Y - Y		
	**a	x	t	in	x	in	kg/m	lb/ft		I	S	r	I	S	r
	mm	x	mm	in	x	in			cm ²	cm ⁴	cm ³	cm	cm ⁴	cm ³	cm
SOL	64	x	6	2 1/2	x	1/4	3.16	2.13	4.03	13.55	4.27	1.83	0.14	0.04	0.18
SOL	64	x	8	2 1/2	x	5/16	3.95	2.65	5.04	16.94	5.33	1.83	0.26	0.08	0.23
SOL	64	x	10	2 1/2	x	3/8	4.75	3.19	6.05	20.32	6.40	1.83	0.46	0.14	0.27
SOL	64	x	13	2 1/2	x	1/2	6.33	4.25	8.06	27.10	8.54	1.83	1.08	0.34	0.37
SOL	64	x	16	2 1/2	x	5/8	7.91	5.32	10.08	33.87	10.67	1.83	2.12	0.67	0.46
SOL	64	x	19	2 1/2	x	3/4	9.49	6.38	12.10	40.65	12.80	1.83	3.66	1.15	0.55
SOL	64	x	25	2 1/2	x	1	12.66	8.51	16.13	54.20	17.07	1.83	8.67	2.73	0.73
SOL	64	x	32	2 1/2	x	1 1/4	15.82	10.63	20.16	67.75	21.34	1.83	16.94	5.33	0.92
SOL	64	x	38	2 1/2	x	1 1/2	18.99	12.76	24.19	81.30	25.61	1.83	29.27	9.22	1.10
SOL	70	x	5	2 3/4	x	3/16	2.61	1.75	3.33	13.53	3.87	2.02	0.06	0.02	0.14
SOL	70	x	6	2 3/4	x	1/4	3.48	2.34	4.44	18.03	5.16	2.02	0.15	0.04	0.18
SOL	70	x	8	2 3/4	x	5/16	4.34	2.92	5.54	22.54	6.45	2.02	0.29	0.08	0.23
SOL	70	x	10	2 3/4	x	3/8	5.22	3.51	6.65	27.05	7.75	2.02	0.50	0.14	0.27
SOL	70	x	13	2 3/4	x	1/2	6.96	4.68	8.87	36.07	10.33	2.02	1.19	0.34	0.37
SOL	70	x	16	2 3/4	x	5/8	8.70	5.85	11.09	45.09	12.91	2.02	2.33	0.67	0.46
SOL	70	x	19	2 3/4	x	3/4	10.44	7.02	13.31	54.10	15.49	2.02	4.02	1.15	0.55
SOL	70	x	25	2 3/4	x	1	13.93	9.36	17.74	72.14	20.65	2.02	9.54	2.73	0.73
SOL	70	x	32	2 3/4	x	1 1/4	17.41	11.70	22.18	90.17	25.82	2.02	18.63	5.33	0.92
SOL	70	x	38	2 3/4	x	1 1/2	20.89	14.04	26.61	108.21	30.98	2.02	32.19	9.22	1.10
SOL	76	x	6	3	x	1/4	3.80	2.55	4.84	23.41	6.15	2.20	0.16	0.04	0.18
SOL	76	x	8	3	x	5/16	4.74	3.19	6.05	29.27	7.68	2.20	0.32	0.08	0.23
SOL	76	x	10	3	x	3/8	5.70	3.83	7.26	35.12	9.22	2.20	0.55	0.14	0.27
SOL	76	x	13	3	x	1/2	7.60	5.10	9.68	46.83	12.29	2.20	1.30	0.34	0.37
SOL	76	x	16	3	x	5/8	9.49	6.38	12.10	58.53	15.36	2.20	2.54	0.67	0.46
SOL	76	x	19	3	x	3/4	11.39	7.66	14.52	70.24	18.44	2.20	4.39	1.15	0.55
SOL	76	x	25	3	x	1	15.19	10.21	19.35	93.65	24.58	2.20	10.41	2.73	0.73
SOL	76	x	32	3	x	1 1/4	18.99	12.76	24.19	117.07	30.73	2.20	20.32	5.33	0.92
SOL	76	x	38	3	x	1 1/2	22.79	15.31	29.03	140.48	36.87	2.20	35.12	9.22	1.10
SOL	89	x	6	3 1/2	x	1/4	4.43	2.98	5.65	37.18	8.36	2.57	0.19	0.04	0.18
SOL	89	x	8	3 1/2	x	5/16	5.53	3.72	7.06	46.47	10.46	2.57	0.37	0.08	0.23
SOL	89	x	10	3 1/2	x	3/8	6.65	4.47	8.47	55.77	12.55	2.57	0.64	0.14	0.27
SOL	89	x	13	3 1/2	x	1/2	8.86	5.95	11.29	74.36	16.73	2.57	1.52	0.34	0.37
SOL	89	x	16	3 1/2	x	5/8	11.08	7.44	14.11	92.95	20.91	2.57	2.96	0.67	0.46
SOL	89	x	19	3 1/2	x	3/4	13.29	8.93	16.94	111.54	25.09	2.57	5.12	1.15	0.55
SOL	89	x	25	3 1/2	x	1	17.72	11.91	22.58	148.72	33.46	2.57	12.14	2.73	0.73
SOL	89	x	29	3 1/2	x	1	19.94	13.40	25.40	167.31	37.64	2.57	17.29	3.89	0.82
SOL	89	x	32	3 1/2	x	1 1/4	22.15	14.89	28.23	185.90	41.82	2.57	23.71	5.33	0.92
SOL	89	x	38	3 1/2	x	1 1/2	26.59	17.86	33.87	223.08	50.19	2.57	40.97	9.22	1.10
SOL	95	x	6	3 3/4	x	1/4	4.75	3.19	6.05	45.73	9.60	2.75	0.20	0.04	0.18
SOL	95	x	8	3 3/4	x	5/16	5.92	3.98	7.56	57.16	12.00	2.75	0.40	0.08	0.23
SOL	95	x	10	3 3/4	x	3/8	7.12	4.79	9.07	68.59	14.40	2.75	0.69	0.14	0.27
SOL	95	x	13	3 3/4	x	1/2	9.49	6.38	12.10	91.46	19.20	2.75	1.63	0.34	0.37
SOL	95	x	16	3 3/4	x	5/8	11.87	7.98	15.12	114.32	24.00	2.75	3.18	0.67	0.46
SOL	95	x	19	3 3/4	x	3/4	14.24	9.57	18.15	137.19	28.81	2.75	5.49	1.15	0.55
SOL	95	x	25	3 3/4	x	1	18.99	12.76	24.19	182.92	38.41	2.75	13.01	2.73	0.73
SOL	95	x	32	3 3/4	x	1 1/4	23.74	15.95	30.24	228.65	48.01	2.75	25.41	5.33	0.92
SOL	95	x	38	3 3/4	x	1 1/2	28.48	19.14	36.29	274.38	57.61	2.75	43.90	9.22	1.10

ASTM A36 / A36M	$f_y = 2,530 \text{ kg/cm}^2$
ASTM A529 / A529M G50	$f_y = 3,515 \text{ kg/cm}^2$
ASTM A572 / A572M G50	$f_y = 3,515 \text{ kg/cm}^2$
ASTM A572 / A572M G60	$f_y = 4,200 \text{ kg/cm}^2$

Los productos en franja amarilla, son de existencia frecuente.

* La resistencia es sólo valor de referencia.

** Redondeado al milímetro.

SOL

SOLERA

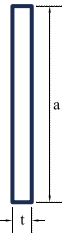

DIMENSIONES



PROPIEDADES

Designación						Peso		Área	Eje X - X			Eje Y - Y			
PERFIL	**a	x	t			kg/m	lb/ft		I	S	r	I	S	r	
	mm	x	mm	in	x	in		cm ²	cm ⁴	cm ³	cm	cm ⁴	cm ³	cm	
SOL	102	x	6	4	x	1/4	5.06	3.40	6.45	55.50	10.92	2.93	0.22	0.04	0.18
SOL	102	x	8	4	x	5/16	6.32	4.25	8.06	69.37	13.66	2.93	0.42	0.08	0.23
SOL	102	x	10	4	x	3/8	7.60	5.10	9.68	83.25	16.39	2.93	0.73	0.14	0.27
SOL	102	x	11	4	x	7/16	8.86	5.95	11.29	97.12	19.12	2.93	1.16	0.23	0.32
SOL	102	x	13	4	x	1/2	10.13	6.81	12.90	111.00	21.85	2.93	1.73	0.34	0.37
SOL	102	x	16	4	x	5/8	12.66	8.51	16.13	138.75	27.31	2.93	3.39	0.67	0.46
SOL	102	x	19	4	x	3/4	15.19	10.21	19.35	166.50	32.77	2.93	5.85	1.15	0.55
SOL	102	x	25	4	x	1	20.26	13.61	25.81	221.99	43.70	2.93	13.87	2.73	0.73
SOL	102	x	32	4	x	1 1/4	25.32	17.01	32.26	277.49	54.62	2.93	27.10	5.33	0.92
SOL	102	x	38	4	x	1 1/2	30.38	20.42	38.71	332.99	65.55	2.93	46.83	9.22	1.10
SOL	114	x	6	4 1/2	x	1/4	5.70	3.83	7.26	79.02	13.83	3.30	0.24	0.04	0.18
SOL	114	x	8	4 1/2	x	5/16	7.11	4.78	9.07	98.78	17.28	3.30	0.48	0.08	0.23
SOL	114	x	10	4 1/2	x	3/8	8.55	5.74	10.89	118.53	20.74	3.30	0.82	0.14	0.27
SOL	114	x	13	4 1/2	x	1/2	11.39	7.66	14.52	158.04	27.65	3.30	1.95	0.34	0.37
SOL	114	x	16	4 1/2	x	5/8	14.24	9.57	18.15	197.55	34.57	3.30	3.81	0.67	0.46
SOL	114	x	19	4 1/2	x	3/4	17.09	11.48	21.77	237.06	41.48	3.30	6.59	1.15	0.55
SOL	114	x	25	4 1/2	x	1	22.79	15.31	29.03	316.08	55.31	3.30	15.61	2.73	0.73
SOL	114	x	32	4 1/2	x	1 1/4	28.48	19.14	36.29	395.10	69.13	3.30	30.49	5.33	0.92
SOL	114	x	38	4 1/2	x	1 1/2	34.18	22.97	43.55	474.12	82.96	3.30	52.68	9.22	1.10
SOL	127	x	6	5	x	1/4	6.33	4.25	8.06	108.40	17.07	3.67	0.27	0.04	0.18
SOL	127	x	8	5	x	5/16	7.90	5.31	10.08	135.49	21.34	3.67	0.53	0.08	0.23
SOL	127	x	10	5	x	3/8	9.49	6.38	12.10	162.59	25.61	3.67	0.91	0.14	0.27
SOL	127	x	13	5	x	1/2	12.66	8.51	16.13	216.79	34.14	3.67	2.17	0.34	0.37
SOL	127	x	16	5	x	5/8	15.82	10.63	20.16	270.99	42.68	3.67	4.23	0.67	0.46
SOL	127	x	19	5	x	3/4	18.99	12.76	24.19	325.19	51.21	3.67	7.32	1.15	0.55
SOL	127	x	25	5	x	1	25.32	17.01	32.26	433.58	68.28	3.67	17.34	2.73	0.73
SOL	127	x	32	5	x	1 1/4	31.65	21.27	40.32	541.98	85.35	3.67	33.87	5.33	0.92
SOL	127	x	38	5	x	1 1/2	37.98	25.52	48.39	650.37	102.42	3.67	58.53	9.22	1.10
SOL	140	x	6	5 1/2	x	1/4	6.96	4.68	8.87	144.27	20.65	4.03	0.30	0.04	0.18
SOL	140	x	8	5 1/2	x	5/16	8.69	5.84	11.09	180.34	25.82	4.03	0.58	0.08	0.23
SOL	140	x	10	5 1/2	x	3/8	10.44	7.02	13.31	216.41	30.98	4.03	1.01	0.14	0.27
SOL	140	x	13	5 1/2	x	1/2	13.93	9.36	17.74	288.55	41.31	4.03	2.38	0.34	0.37
SOL	140	x	16	5 1/2	x	5/8	17.41	11.70	22.18	360.69	51.64	4.03	4.66	0.67	0.46
SOL	140	x	19	5 1/2	x	3/4	20.89	14.04	26.61	432.82	61.96	4.03	8.05	1.15	0.55
SOL	140	x	25	5 1/2	x	1	27.85	18.72	35.48	577.10	82.62	4.03	19.08	2.73	0.73
SOL	140	x	32	5 1/2	x	1 1/4	34.81	23.39	44.36	721.37	103.27	4.03	37.26	5.33	0.92
SOL	140	x	38	5 1/2	x	1 1/2	41.78	28.07	53.23	865.64	123.93	4.03	64.39	9.22	1.10
SOL	152	x	6	6	x	1/4	7.60	5.10	9.68	187.31	24.58	4.40	0.33	0.04	0.18
SOL	152	x	8	6	x	5/16	9.48	6.37	12.10	234.13	30.73	4.40	0.64	0.08	0.23
SOL	152	x	10	6	x	3/8	11.39	7.66	14.52	280.96	36.87	4.40	1.10	0.14	0.27
SOL	152	x	13	6	x	1/2	15.19	10.21	19.35	374.61	49.16	4.40	2.60	0.34	0.37
SOL	152	x	16	6	x	5/8	18.99	12.76	24.19	468.27	61.45	4.40	5.08	0.67	0.46
SOL	152	x	19	6	x	3/4	22.79	15.31	29.03	561.92	73.74	4.40	8.78	1.15	0.55
SOL	152	x	25	6	x	1	30.38	20.42	38.71	749.23	98.32	4.40	20.81	2.73	0.73
SOL	152	x	32	6	x	1 1/4	37.98	25.52	48.39	936.54	122.90	4.40	40.65	5.33	0.92
SOL	152	x	38	6	x	1 1/2	45.58	30.63	58.06	1123.84	147.49	4.40	70.24	9.22	1.10

ASTM A36 / A36M $f_y = 2,530 \text{ kg/cm}^2$
 ASTM A529 / A529M G50 $f_y = 3,515 \text{ kg/cm}^2$
 ASTM A572 / A572M G50 $f_y = 3,515 \text{ kg/cm}^2$
 ASTM A572 / A572M G60 $f_y = 4,200 \text{ kg/cm}^2$

Los productos en franja amarilla, son de existencia frecuente.

* La resistencia es sólo valor de referencia.

** Redondeado al milímetro.



SOL

SOLERA

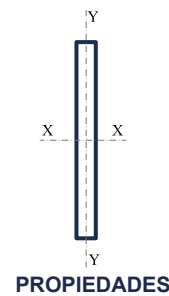
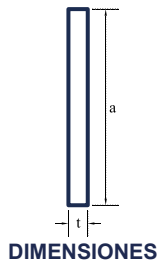

HAZLO EN GRANDE, PIENSA EN ACERO.

Designación						Peso		Área	Eje X - X			Eje Y - Y			
PERFIL	**a	x	t			kg/m	lb/ft		l	S	r	l	S	r	
	mm	x	mm	in	x	in		cm ²	cm ⁴	cm ³	cm	cm ⁴	cm ³	cm	
SOL	178	x	6	7	x	1/4	8.86	5.95	11.29	297.44	33.46	5.13	0.38	0.04	0.18
SOL	178	x	8	7	x	5/16	11.08	7.44	14.11	371.80	41.82	5.13	0.74	0.08	0.23
SOL	178	x	10	7	x	3/8	13.29	8.93	16.94	446.16	50.19	5.13	1.28	0.14	0.27
SOL	178	x	13	7	x	1/2	17.73	11.91	22.58	594.87	66.91	5.13	3.04	0.34	0.37
SOL	178	x	16	7	x	5/8	22.16	14.89	28.23	743.59	83.64	5.13	5.93	0.67	0.46
SOL	178	x	19	7	x	3/4	26.59	17.86	33.87	892.31	100.37	5.13	10.24	1.15	0.55
SOL	178	x	25	7	x	1	35.45	23.82	45.16	1189.75	133.83	5.13	24.28	2.73	0.73
SOL	178	x	32	7	x	1 1/4	44.31	29.77	56.45	1487.18	167.29	5.13	47.42	5.33	0.92
SOL	178	x	38	7	x	1 1/2	53.18	35.73	67.74	1784.62	200.74	5.13	81.95	9.22	1.10
SOL	203	x	6	8	x	1/4	10.13	6.81	12.90	443.99	43.70	5.87	0.43	0.04	0.18
SOL	203	x	8	8	x	5/16	12.66	8.51	16.13	554.98	54.62	5.87	0.85	0.08	0.23
SOL	203	x	10	8	x	3/8	15.19	10.21	19.35	665.98	65.55	5.87	1.46	0.14	0.27
SOL	203	x	13	8	x	1/2	20.26	13.61	25.81	887.97	87.40	5.87	3.47	0.34	0.37
SOL	203	x	16	8	x	5/8	25.32	17.01	32.26	1109.97	109.25	5.87	6.77	0.67	0.46
SOL	203	x	19	8	x	3/4	30.39	20.42	38.71	1331.96	131.10	5.87	11.71	1.15	0.55
SOL	203	x	25	8	x	1	40.52	27.22	51.61	1775.95	174.80	5.87	27.75	2.73	0.73
SOL	203	x	32	8	x	1 1/4	50.65	34.03	64.52	2219.94	218.50	5.87	54.20	5.33	0.92
SOL	203	x	38	8	x	1 1/2	60.77	40.83	77.42	2663.92	262.20	5.87	93.65	9.22	1.10
SOL	229	x	6	9	x	1/4	11.40	7.66	14.52	632.16	55.31	6.60	0.49	0.04	0.18
SOL	229	x	8	9	x	5/16	14.24	9.57	18.15	790.20	69.13	6.60	0.95	0.08	0.23
SOL	229	x	10	9	x	3/8	17.09	11.48	21.77	948.24	82.96	6.60	1.65	0.14	0.27
SOL	229	x	13	9	x	1/2	22.79	15.31	29.03	1264.32	110.61	6.60	3.90	0.34	0.37
SOL	229	x	16	9	x	5/8	28.49	19.14	36.29	1580.40	138.27	6.60	7.62	0.67	0.46
SOL	229	x	19	9	x	3/4	34.19	22.97	43.55	1896.48	165.92	6.60	13.17	1.15	0.55
SOL	229	x	25	9	x	1	45.58	30.62	58.06	2528.65	221.23	6.60	31.22	2.73	0.73
SOL	229	x	32	9	x	1 1/4	56.98	38.28	72.58	3160.81	276.53	6.60	60.97	5.33	0.92
SOL	229	x	38	9	x	1 1/2	68.37	45.94	87.10	3792.97	331.84	6.60	105.36	9.22	1.10
SOL	254	x	6	10	x	1/4	12.66	8.51	16.13	867.16	68.28	7.33	0.54	0.04	0.18
SOL	254	x	8	10	x	5/16	15.83	10.63	20.16	1083.95	85.35	7.33	1.06	0.08	0.23
SOL	254	x	10	10	x	3/8	18.99	12.76	24.19	1300.74	102.42	7.33	1.83	0.14	0.27
SOL	254	x	13	10	x	1/2	25.32	17.01	32.26	1734.32	136.56	7.33	4.34	0.34	0.37
SOL	254	x	16	10	x	5/8	31.65	21.27	40.32	2167.91	170.70	7.33	8.47	0.67	0.46
SOL	254	x	19	10	x	3/4	37.98	25.52	48.39	2601.49	204.84	7.33	14.63	1.15	0.55
SOL	254	x	25	10	x	1	50.65	34.03	64.52	3468.65	273.12	7.33	34.69	2.73	0.73
SOL	254	x	32	10	x	1 1/4	63.31	42.53	80.65	4335.81	341.40	7.33	67.75	5.33	0.92
SOL	254	x	38	10	x	1 1/2	75.97	51.04	96.77	5202.97	409.68	7.33	117.07	9.22	1.10
SOL	305	x	6	12	x	1/4	15.19	10.21	19.35	1498.46	98.32	8.80	0.65	0.04	0.18
SOL	305	x	8	12	x	5/16	18.99	12.76	24.19	1873.07	122.90	8.80	1.27	0.08	0.23
SOL	305	x	10	12	x	3/8	22.79	15.31	29.03	2247.69	147.49	8.80	2.20	0.14	0.27
SOL	305	x	13	12	x	1/2	30.39	20.42	38.71	2996.91	196.65	8.80	5.20	0.34	0.37
SOL	305	x	16	12	x	5/8	37.98	25.52	48.39	3746.14	245.81	8.80	10.16	0.67	0.46
SOL	305	x	19	12	x	3/4	45.58	30.62	58.06	4495.37	294.97	8.80	17.56	1.15	0.55
SOL	305	x	25	12	x	1	60.77	40.83	77.42	5993.83	393.29	8.80	41.62	2.73	0.73
SOL	305	x	32	12	x	1 1/4	75.97	51.04	96.77	7492.28	491.62	8.80	81.30	5.33	0.92
SOL	305	x	38	12	x	1 1/2	91.16	61.25	116.13	8990.74	589.94	8.80	140.48	9.22	1.10
SOL	356	x	6	14	x	1/4	17.73	11.91	22.58	2379.49	133.83	10.27	0.76	0.04	0.18
SOL	356	x	8	14	x	5/16	22.16	14.89	28.23	2974.37	167.29	10.27	1.48	0.08	0.23
SOL	356	x	10	14	x	3/8	26.59	17.86	33.87	3569.24	200.74	10.27	2.56	0.14	0.27
SOL	356	x	13	14	x	1/2	35.45	23.82	45.16	4758.99	267.66	10.27	6.07	0.34	0.37
SOL	356	x	16	14	x	5/8	44.31	29.77	56.45	5948.73	334.57	10.27	11.86	0.67	0.46
SOL	356	x	19	14	x	3/4	53.18	35.73	67.74	7138.48	401.49	10.27	20.49	1.15	0.55
SOL	356	x	25	14	x	1	70.90	47.64	90.32	9517.98	535.32	10.27	48.56	2.73	0.73
SOL	356	x	32	14	x	1 1/4	88.63	59.55	112.90	11897.47	669.15	10.27	94.85	5.33	0.92
SOL	356	x	38	14	x	1 1/2	106.36	71.45	135.48	14276.96	802.98	10.27	163.89	9.22	1.10

ASTM A36 / A36M	$f_y = 2,530 \text{ kg/cm}^2$
ASTM A529 / A529M G50	$f_y = 3,515 \text{ kg/cm}^2$
ASTM A572 / A572M G50	$f_y = 3,515 \text{ kg/cm}^2$
ASTM A572 / A572M G60	$f_y = 4,200 \text{ kg/cm}^2$

Los productos en franja amarilla, son de existencia frecuente.

* La resistencia es sólo valor de referencia.

** Redondeado al milímetro.

OS

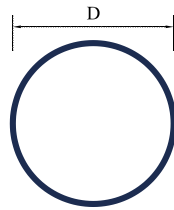
REDONDO
SÓLIDO

DIMENSIONES

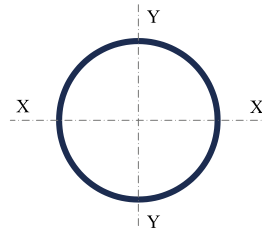

PROPIEDADES

Designación diámetro		Peso		Área	Ejes X - X y Y - Y		
mm	in	kg/m	lb/ft		I	S	r
				cm ²	cm ⁴	cm ³	cm
9.5	3/8	0.559	0.376	0.713	0.040	0.084	0.238
11.1	7/16	0.760	0.511	0.970	0.075	0.134	0.278
12.7	1/2	0.994	0.668	1.267	0.128	0.201	0.318
14.3	9/16	1.257	0.845	1.603	0.205	0.287	0.358
15.9	5/8	1.552	1.043	1.979	0.314	0.395	0.398
17.5	11/16	1.878	1.262	2.395	0.460	0.526	0.438
19.1	3/4	2.235	1.502	2.850	0.653	0.684	0.478
20.6	13/16	2.622	1.762	3.345	0.884	0.858	0.515
22.2	7/8	3.045	2.046	3.879	1.192	1.074	0.555
23.8	15/16	3.491	2.346	4.453	1.575	1.324	0.595
25.4	1	3.973	2.669	5.067	2.043	1.609	0.635
27.0	1 1/16	4.484	3.013	5.720	2.610	1.932	0.675
28.6	1 1/8	5.022	3.375	6.413	3.284	2.297	0.715
30.2	1 3/16	5.605	3.767	7.145	4.083	2.704	0.755
31.8	1 1/4	6.208	4.172	7.917	5.020	3.157	0.795
33.3	1 5/16	6.845	4.599	8.729	6.036	3.625	0.833
34.9	1 3/8	7.514	5.049	9.580	7.282	4.173	0.873
36.5	1 7/16	8.212	5.518	10.471	8.712	4.774	0.913
38.1	1 1/2	9.000	6.048	11.401	10.343	5.430	0.953
39.7	1 9/16	9.702	6.519	12.371	12.178	6.137	0.992
41.3	1 5/8	10.490	7.049	13.380	14.281	6.916	1.033
42.9	1 11/16	11.317	7.604	14.429	16.568	7.731	1.072
44.5	1 3/4	12.170	8.178	15.518	19.250	8.651	1.113
46.0	1 13/16	13.056	8.773	16.646	22.050	9.579	1.151
47.7	1 7/8	13.970	9.388	17.813	25.412	10.655	1.193
49.2	1 15/16	14.918	10.024	19.021	28.792	11.701	1.230
50.8	2	15.890	10.681	20.268	32.690	12.870	1.270
52.4	2 1/16	16.905	11.359	21.555	36.973	14.115	1.310

ASTM A36 / A36M $f_y = 2,530 \text{ kg/cm}^2$ ASTM A529 / A529M G50 $f_y = 3,515 \text{ kg/cm}^2$ ASTM A572 / A572M G50 $f_y = 3,515 \text{ kg/cm}^2$

SAE 1018

SAE 1030

SAE 1045

SAE 1050

SAE 1055

SAE 1060

SAE 1080

SAE 4140

Los productos en franja amarilla, son de existencia frecuente.

* La resistencia es sólo valor de referencia.

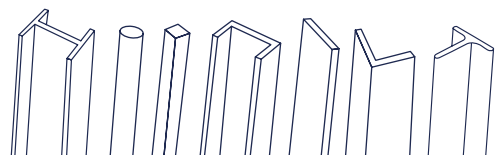

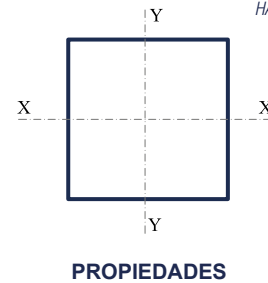
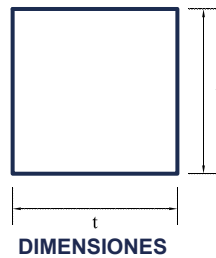

Designación lado	Peso				Área	Ejes X -X y Y - Y		
	PERFIL	mm	in	kg/m		lb/ft	I	S
					cm ²	cm ⁴	cm ³	cm
CS	9.5	3/8	0.712	0.478	0.907	0.069	1.44E-03	0.275
CS	11.1	7/16	0.969	0.651	1.235	0.127	2.29E-03	0.321
CS	12.7	1/2	1.266	0.850	1.613	0.217	3.41E-03	0.367
CS	15.9	5/8	1.978	1.328	2.520	0.529	6.668E-03	0.458
CS	19.1	3/4	2.848	1.912	3.629	1.097	1.152E-02	0.550
CS	20.6	13/16	3.342	2.244	4.259	1.512	1.465E-02	0.596
CS	22.2	7/8	3.876	2.602	4.940	2.033	1.830E-02	0.642
CS	23.8	15/16	4.450	2.987	5.670	2.679	2.250E-02	0.687
CS	25.4	1	5.063	3.399	6.452	3.469	2.731E-02	0.733
CS	27.0	1 1/16	5.715	3.837	7.283	4.420	3.276E-02	0.779
CS	28.6	1 1/8	6.407	4.301	8.165	5.556	3.889E-02	0.825
CS	30.2	1 3/16	7.139	4.793	9.098	6.897	4.574E-02	0.871
CS	31.8	1 1/4	7.910	5.310	10.081	8.468	5.334E-02	0.917
CS	33.3	1 5/16	8.721	5.855	11.114	10.293	6.175E-02	0.962
CS	34.9	1 3/8	9.571	6.426	12.198	12.398	7.100E-02	1.008
CS	38.1	1 1/2	11.391	7.647	14.516	17.560	9.218E-02	1.100
CS	39.7	1 9/16	12.360	8.298	15.751	20.674	1.042E-01	1.146
CS	41.3	1 5/8	13.368	8.975	17.036	24.186	1.172E-01	1.192
CS	44.5	1 3/4	15.504	10.409	19.758	32.532	1.464E-01	1.283
CS	50.8	2	20.250	13.595	25.806	55.498	2.185E-01	1.466
CS	57.2	2 1/4	25.629	17.206	32.661	88.896	3.111E-01	1.650

CUADRADO EN MILÉSIMAS DE PULGADA.								
CS	12.0	0.472	1.128	0.757	1.437	0.172	2.872E-03	0.346
CS	13.5	0.532	1.433	0.962	1.826	0.278	4.112E-03	0.390
CS	16.3	0.640	2.074	1.392	2.643	0.582	7.160E-03	0.469
CS	16.7	0.656	2.179	1.463	2.776	0.642	7.710E-03	0.481
CS	16.7	0.657	2.185	1.467	2.785	0.646	7.745E-03	0.482
CS	19.8	0.781	3.088	2.073	3.935	1.290	1.301E-02	0.573
CS	19.9	0.782	3.096	2.078	3.945	1.297	1.306E-02	0.573
CS	26.2	1.032	5.392	3.620	6.871	3.934	3.002E-02	0.757
CS	29.4	1.157	6.777	4.550	8.636	6.216	4.230E-02	0.848

ASTM A36 / A36M $f_y = 2,530 \text{ kg/cm}^2$
 ASTM A529 / A529M G50 $f_y = 3,515 \text{ kg/cm}^2$
 ASTM A572 / A572M G50 $f_y = 3,515 \text{ kg/cm}^2$
 SAE 1018 $f_y = 4,220 \text{ kg/cm}^2$

SAE 1030
 SAE 1045
 SAE 1050
 SAE 1055
 SAE 1060
 SAE 1080
 SAE 4140

Los productos en franja amarilla, son de existencia frecuente.

Los productos sin sombrear, son de fabricación especial, sobre pedido.

5.13 TOLERANCIAS DE LAMINACIÓN

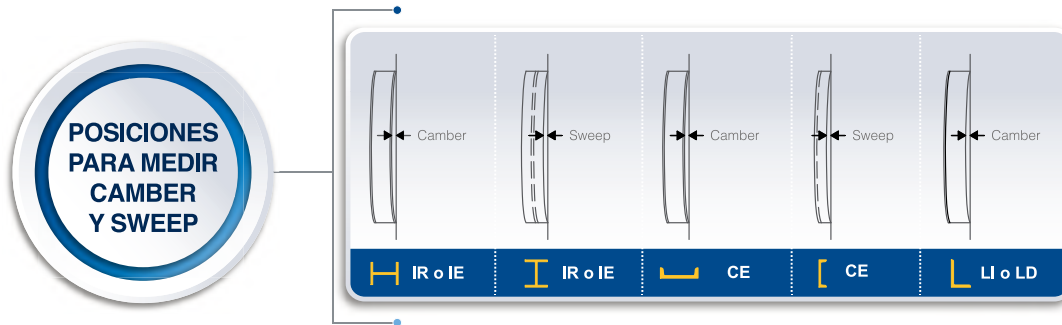

VARIACIÓN PERMISIBLE EN RECTITUD PARA SECCIONES S, M, C, MC, L, T, Z Y ÁNGULOS BULBOS. ASTM A6

Variable	Tamaño nominal en pulgadas (a)	Variaciones permitibles en pulgadas
Camber	Menos de 3	1/8 x (número total de pies en la longitud / 5)
	3 y más	1/8 (número de pies de longitud total / 5)
Sweep	Todos	Debido a las variaciones extremas en la flexibilidad de estas formas, las variaciones permitidas para el barrido están sujetas a negociaciones entre el fabricante y el comprador para las distintas secciones implicadas

(a): La mayor dimensión de la sección transversal

VARIACIONES PERMISIBLES EN RECTITUD PARA SECCIONES IR. ASTM A 6

Características	Variación permisible
Camber y Sweep	1/8 de pulgada x (número total de pies en la longitud / 10) (a)
<p>Cuando ciertas secciones (b) donde el ancho de patín es aproximadamente igual al peralte (secciones H) y son especificadas en el pedido como columnas:</p> <p>Longitudes iguales y abajo de 45 pies</p>	1/8 de pulgada x (número total de pies en la longitud / 10) pero no mayor de 3/8 de pulgada
Longitudes arriba de 45 pies	3/8 de pulgada + [1/8 de pulgada x [(número total de pies en la longitud - 45) / 10]]

(a) : Secciones con ancho de patín menor de 6 pulgadas, la tolerancia para el sweep, es = 1/8 de pulgada x (número total de pies en la longitud / 5)

(b) : Aplica solamente para: Secciones de 8" de peralte 31 lb/pie y mayores Secciones de 12" de peralte 65 lb/pie y mayores
 Secciones de 10" de peralte 49 lb/pie y mayores Secciones de 14" de peralte 90 lb/pie y mayores

VARIACIÓN PERMISIBLE EN LONGITUD PARA VIGAS IR. ASTM A6

Perfil	Variaciones de longitud específica a longitudes dadas, en pulgadas ^{A B}			
	30 pies y menores		Mayor a 30 pies	
	Arriba	Abajo	Arriba	Abajo
Vigas de 24" y menos de peralte nominal	3/8 "	3/8 "	3/8" más 1/16" por cada 5 pies o fracción adicional.	3/8 "
Vigas de más de 24" de peralte nominal y todas las columnas	1/2 "	1/2 "	1/2" más 1/16" por cada 5 pies o fracción adicional	1/2 "

^A Para las secciones IR especificadas en el pedido de uso como pilotes de soporte, las variaciones permitidas de longitud son más 5 pulgadas y menos 0 pulgadas. Estas variaciones permitidas de longitud también se aplican a las tablestacas.

^B Las variaciones permitidas en el extremo sin cuadrado para las formas de W y HP serán 1/64 pulgadas por pulgada de profundidad, o por pulgada de ancho de ala si el ancho de ala es mayor que la profundidad.



PATINES FUERA DE ESCUADRA.

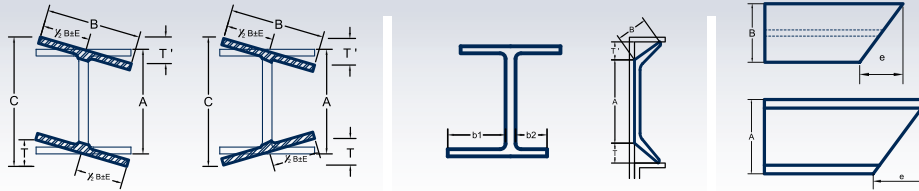

$$E = \frac{b1 - b2}{2}$$

E = Alma fuera de centro o descentrada
A = Peralte

B = Ancho de patín
e = Extremos fuera de escuadra

VARIACIONES PERMITIDAS EN LA SECCIÓN TRANSVERSAL PARA LOS PERFILES IR, S, M, C, MC. ASTM A6

Perfil	Sección en medidas nominales pulgadas	Variaciones permitidas en dimensiones transversales dadas en pulgadas.							Variaciones permitidas sobre o bajo en el alma para espesores dados en pulgadas.	
		A, Longitud		B, Ancho de alas		T + T ^{MA} , alas fuera de escuadra, pulgadas. ^B	E alma fuera del centro, pulgadas. ^C	C, máxima longitud en cualquier transversal sobre el peralte teórico, pulgadas	3/16 ^{II} y menores	mayores a 3/16 ^{II}
		Arriba del teórico	Abajo del teórico	Arriba del teórico	Abajo del teórico					
IR	Hasta 12	1/8	1/8	1/4	3/16	1/4	3/16	1/4	—	—
	mayores a 12	1/8	1/8	1/4	3/16	5/16	3/16	1/4	—	—
S y M	De 3 a 7	3/32	1/16	1/8	1/8	1/32	3/16	—	—	—
	mayores de 7 a 14	1/8	3/32	5/32	5/32	1/32	3/16	—	—	—
	mayores de 14 a 24	3/16	1/8	3/16	3/16	1/32	3/16	—	—	—
C y MC	De 1 1/2 y menores	1/32	1/32	1/32	1/32	1/32	—	—	0.010	0.015
	mayores de 1 1/2 a 3	1/16	1/16	1/16	1/16	1/32	—	—	0.015	0.020
	De 3 a 7	3/32	1/16	1/8	1/8	1/32	—	—	—	—
	mayores de 7 a 14	1/8	3/32	1/8	5/32	1/32	—	—	—	—
	mayores de 14	3/16	1/8	1/8	3/16	1/32	—	—	—	—

^A T + T se aplica cuando las alas de los canales entran o salen. Para canales de 5/8" y menos de peralte, el escuadre permitido es de 3/64" / Pulg. de peralte.

^B La variación permitida es por pulgada de ancho de alas para las secciones S, M, C y MC.

^C Variación permitida de 5/16 in. Max para perfiles de más de 426 lb / ft.

VARIACIONES PERMISIBLES EN EXTREMOS FUERA DE ESCUADRA PARA CANALES. ASTM A 6

Perfil	Variaciones permisibles
CE	1/64 de pulgada / pulgada de peralte

VARIACIÓN PERMITIDA EN LA SECCIÓN TRANSVERSAL PARA ÁNGULOS (PERFIL L)

Perfil	Dimensión nominal pulgadas	Variación permitida en las dimensiones de la sección dada en pulgadas			Las variaciones permitidas más o menos de espesor teórico para espesores. Dada en pulgadas.		
		B, Ancho del ala		T fuera de cuadro en pulgadas por B	3/16 ^{II} y menores	De 3/16 ^{II} hasta 3/8 ^{II}	Mayores a 3/8 ^{II}
Arriba del teórico	Arriba del teórico						
Ángulos ^A L	1 y menores	1/32	1/32	3/128 ^B	0.008	0.01	—
	De 1 a 2	3/64	3/64	3/128 ^B	0.01	0.01	0.012
	De 2 a 3	1/16	1/16	3/128 ^B	0.012	0.015	0.015
	De 3 a 4	1/8	3/32	3/128 ^B	—	—	—
	De 4 a 6	1/8	1/8	3/128 ^B	—	—	—
	Mayores a 6	3/16	1/8	3/128 ^B	—	—	—

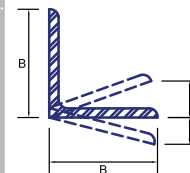

^A Para ángulos de lados desiguales, un lado más largo determina la clasificación.

^B 3/128 pulgadas / pulg. = 1 1/2 grados.

5.14 CARGAS VIVAS

Estas son estipuladas por normas según el uso del inmueble y con base en el acuerdo por el que se actualizaron las Normas Técnicas Complementarias sobre Criterios y Acciones para el Diseño Estructural de las Edificaciones publicadas en la Gaceta Oficial de la Ciudad de México el 15 de diciembre del 2017 y resumidas en la siguiente tabla (para su aplicación referirse a estas normas).

DESTINO DEL PISO O CUBIERTA	CV Carga Viva Media	CVa Carga Viva Instantánea	CVm Carga Viva Máxima	OBSERVACIONES
	kg/m ²	kg/m ²	kg/m ²	
a) Habitación (Casas Habitación, apartamentos, viviendas, dormitorios, cuartos de hotel, internados de escuelas, cuarteles, cárceles, correccionales, hospitales y similares).	80	100	190	1
b) Oficinas, despachos y laboratorios.	100	180	250	2
c) Aulas.	100	180	250	
d) Comunicación para peatones (Pasillos, escaleras, rampas, vestíbulos y pasajes de acceso libre al público).	40	150	350	3 y 4
e) Estadios y lugares de reunión sin asientos individuales.	40	350	450	5
f) Otros lugares de reunión (Templos, cines, teatros, gimnasios, salones de baile, restaurantes, bibliotecas, aulas, salas de juego, y similares).	40	250	350	5
g) Comercios, fábricas y bodegas.	0.8CVm	0.9CVm	CVm	6
h) Cubiertas y azoteas con pendiente no mayor de 5%.	15	70	100	4 y 7
i) Cubiertas y azoteas con pendiente mayor de 5%, otras cubiertas, cualquier pendiente.	5	20	40	4, 7, 8 y 9
j) Volados en vía pública (marquesinas, balcones y similares).	15	70	300	
k) Garajes y estacionamientos (para automóviles exclusivamente).	40	100	250	10



5.15 OBSERVACIONES

1.- Para elementos con área tributaria mayor de 36 m², Wm podrá reducirse, tomando su valor en kN/m² igual a

$$0.60 + 7.8 / \sqrt{A} ; (60 + 780 / \sqrt{A} \text{ en kg/m}^2)$$

Donde A es el área tributaria en m². Cuando sea más desfavorable se considerará en lugar de Wm, una carga de 5 kN (500 kg) aplicada sobre un área de 500×500 mm en la posición más crítica. Para sistemas de piso ligeros con cubierta rigidizante, se considerará en lugar de Wm, cuando sea más desfavorable, una carga concentrada de 2.5 kN (250 kg), para el diseño de los elementos de soporte y de 1 kN (100 kg), para el diseño de la cubierta, en ambos casos ubicadas en la posición más desfavorable. Se considerarán sistemas de piso ligero aquéllos formados por tres o más miembros aproximadamente paralelos y separados entre sí no más de 800 mm y unidos con una cubierta de madera contrachapada, de duelas de madera bien clavadas u otro material que proporcione una rigidez equivalente.

2.- Para elementos con área tributaria mayor de 36 m², Wm podrá reducirse, tomando su valor en kN/m² igual a

$$1.1 + 8.5 / \sqrt{A} ; (110 + 850 / \sqrt{A} \text{ en kg/m}^2)$$

Donde A es el área tributaria en m². Cuando sea más desfavorable se considerará en lugar de Wm, una carga de 10 kN (1000 kg), aplicada sobre un área de 500×500 mm en la posición más crítica. Para sistemas de piso ligero con cubierta rigidizante, definidos como en la nota 1, se considerará en lugar de Wm, cuando sea más desfavorable, una carga concentrada de 5 kN (500 kg), para el diseño de los elementos de soporte y de 1.5 kN (150 kg), para el diseño de la cubierta, ubicadas en la posición más desfavorable.

- 3.- En áreas de comunicación de casas de habitación y edificios de departamentos se considerará la misma carga viva que en el inciso (a), de la tabla.
- 4.- Para el diseño de los pretilas y barandales en escaleras, rampas, pasillos y balcones, se deberá fijar una carga por metro lineal no menor de 1 kN/m (100 kg/m), actuando al nivel de pasamanos y en la dirección más desfavorable.
- 5.- En estos casos deberá prestarse particular atención a la revisión de los estados límite de servicio relativos a vibraciones.
- 6.- Atendiendo al destino del piso se determinará con los criterios de la sección 2.2 la carga unitaria, Wm, que no será inferior a 3.5 kN/m² (350 kg/m²), y deberá especificarse en los planos estructurales y en placas colocadas en lugares fácilmente visibles de la edificación.
- 7.- Las cargas vivas especificadas para cubiertas y azoteas no incluyen las cargas producidas por tinacos y anuncios, ni las que se deben a equipos u objetos pesados que puedan apoyarse en o colgarse del techo. Estas cargas deben preverse por separado y especificarse en los planos estructurales. Adicionalmente, los elementos de las cubiertas y azoteas deberán revisarse con una carga concentrada de 1 kN (100 kg), en la posición más crítica.
- 8.- Además, en el fondo de los valles de techos inclinados se considerará una carga debida al granizo de 0.3 kN (30 kg), por cada metro cuadrado de proyección horizontal del techo que desagüe hacia el valle. Esta carga se considerará como una acción accidental para fines de revisión de la seguridad y se le aplicarán los factores de carga correspondientes según la sección 3.4.
- 9.- Para tomar en cuenta el efecto del granizo, Wm se tomará igual a 1.0 kN/m² (100 kg/m²), y se tratará como una carga accidental para fines de calcular los factores de carga de acuerdo con lo establecido en la sección 3.4. Esta carga no es aditiva a la que se menciona en el inciso (i) de la tabla y en la nota 8.
- 10.- Más una concentración de 15 kN (1500 kg), en el lugar más desfavorable del miembro estructural de que se trate.

La Carga Viva Media se utiliza para revisar el estado límite de servicio, la Carga Viva Instantánea se utiliza para revisar el estado límite de falla en condiciones de fuerzas accidentales y la Carga Viva Máxima se utiliza para revisar el estado límite de falla únicamente por fuerzas gravitacionales.

TABLAS DE PESO Y MEDIDAS

LONGITUD

1,000 milímetros	=	1	metro
100 centímetros	=	1	metro
1,000 metros	=	1	kilómetro
1 kilómetro	=	1,000	metros
1 hectómetro	=	100	metros
1 decámetro	=	10	metros
1 decímetro	=	0.1	metro
1 centímetro	=	0.01	metro
1 milímetro	=	0.001	metro

PESO

1,000 gramos	=	1	kilogramo
1,000 kilogramos	=	1	tonelada
1 kilogramo	=	1000	gramos
1 hectógramo	=	100	gramos
1 decagramo	=	10	gramos
1 decigramo	=	0.1	gramo
1 centigramo	=	0.01	gramo
1 miligramo	=	0.001	gramo
1 oz (onza)	=	28.3495	gramos
1 lb (libra)	=	453.592	gramos
1 ton (tonelada)	=	1,000	kilogramos
1 Short ton	=	907.18474	kilogramos

LONGITUD

1 inch (pulgada)	=	2.54	centímetros	cm
1 inch (pulgada)	=	25.4	milímetros	mm
1 ft (pie)	=	30.48	centímetros	cm
1 ft (pie)	=	0.3048	metro	m
1 yd (yarda)	=	0.9144	metro	m
1 yd (yarda)	=	91.44	centímetros	cm
1 ml (milla)	=	1.6093	kilómetros	km

ÁREA

1 in ² (pulgada cuadrada)	=	6.4516	cm ² (centímetros cuadrados)
1 ft ² (pie cuadrado)	=	144	in ² (pulgadas cuadradas)
1 ft ² (pie cuadrado)	=	0.09290	m ² (metro cuadrado)
1 yd ² (yarda cuadrada)	=	0.8361	m ² (metro cuadrado)
1 ml ² (milla cuadrada)	=	2.59	km ² (kilómetros cuadrados)
1 acre (acre)	=	4,046.85	m ² (metros cuadrados)
1 acre (acre)	=	0.404685	hectáreas

VOLUMEN

1,000 mililitros	=	1	litro
250 mililitros	=	1	taza métrica
1 tsp (cucharadita)	=	5	mililitros
1 tbsp (cucharada)	=	14.7867	mililitros
1 fl oz (onza líquida)	=	29.5735	mililitros
1 c (cup o taza)	=	236.58	mililitros
1 pt (pint o pinta)	=	473.1764	mililitros
1 qt (quart o cuarto)	=	946.35	mililitros
1 gal (gallon o galón)	=	3.7852	litros
1 ft ³ (pie cúbico)	=	28.3168	litros
1 ft ³ (pie cúbico)	=	0.0283168	metros ³
1 yd ³ (yarda cúbica)	=	0.7645	metros ³
1 yd ³ (yarda cúbica)	=	27	pies ³
1 yd ³ (yarda cúbica)	=	764.5536	litros



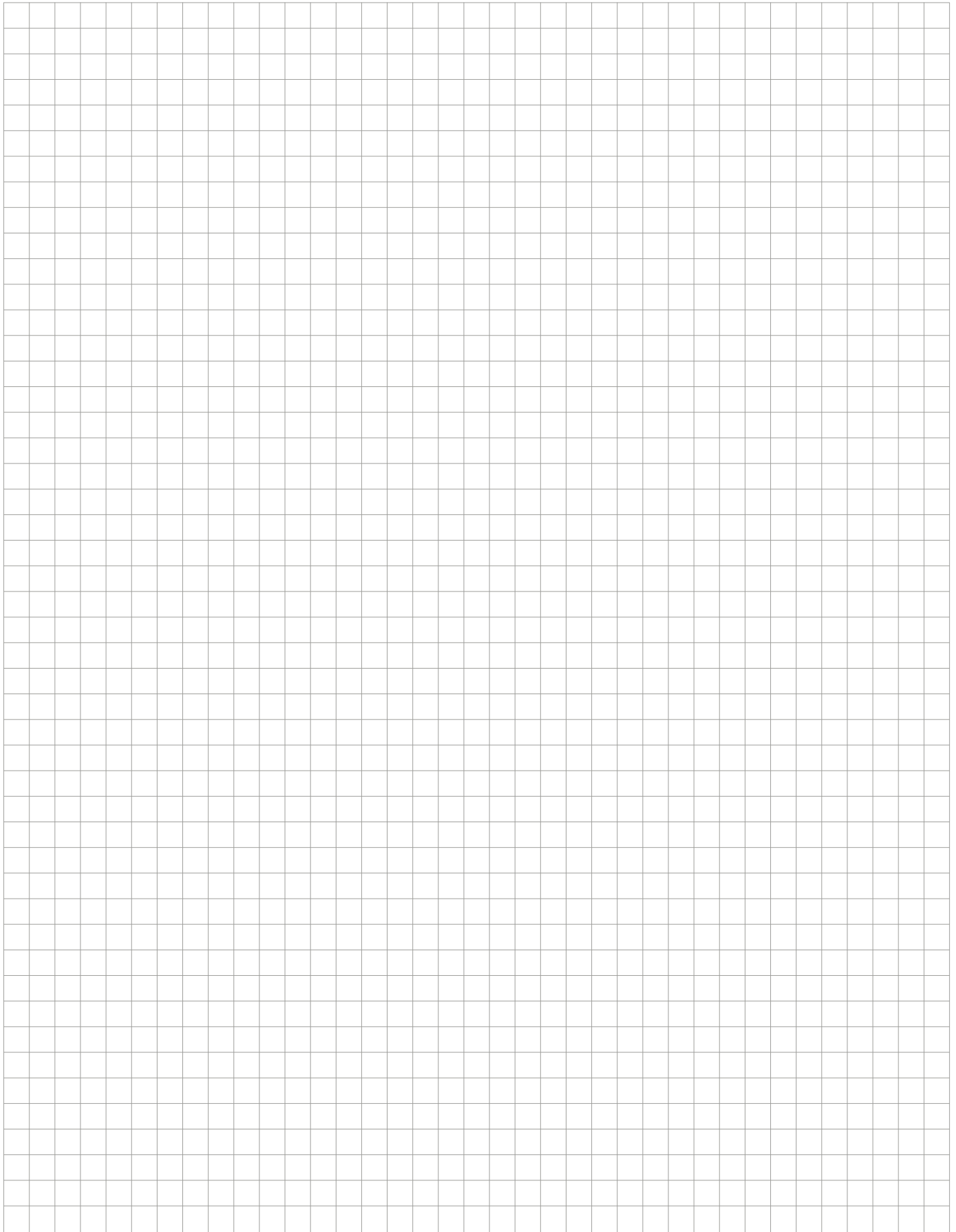

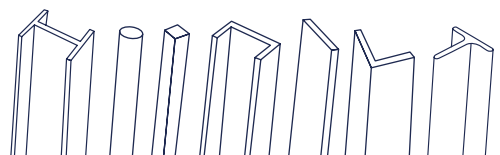
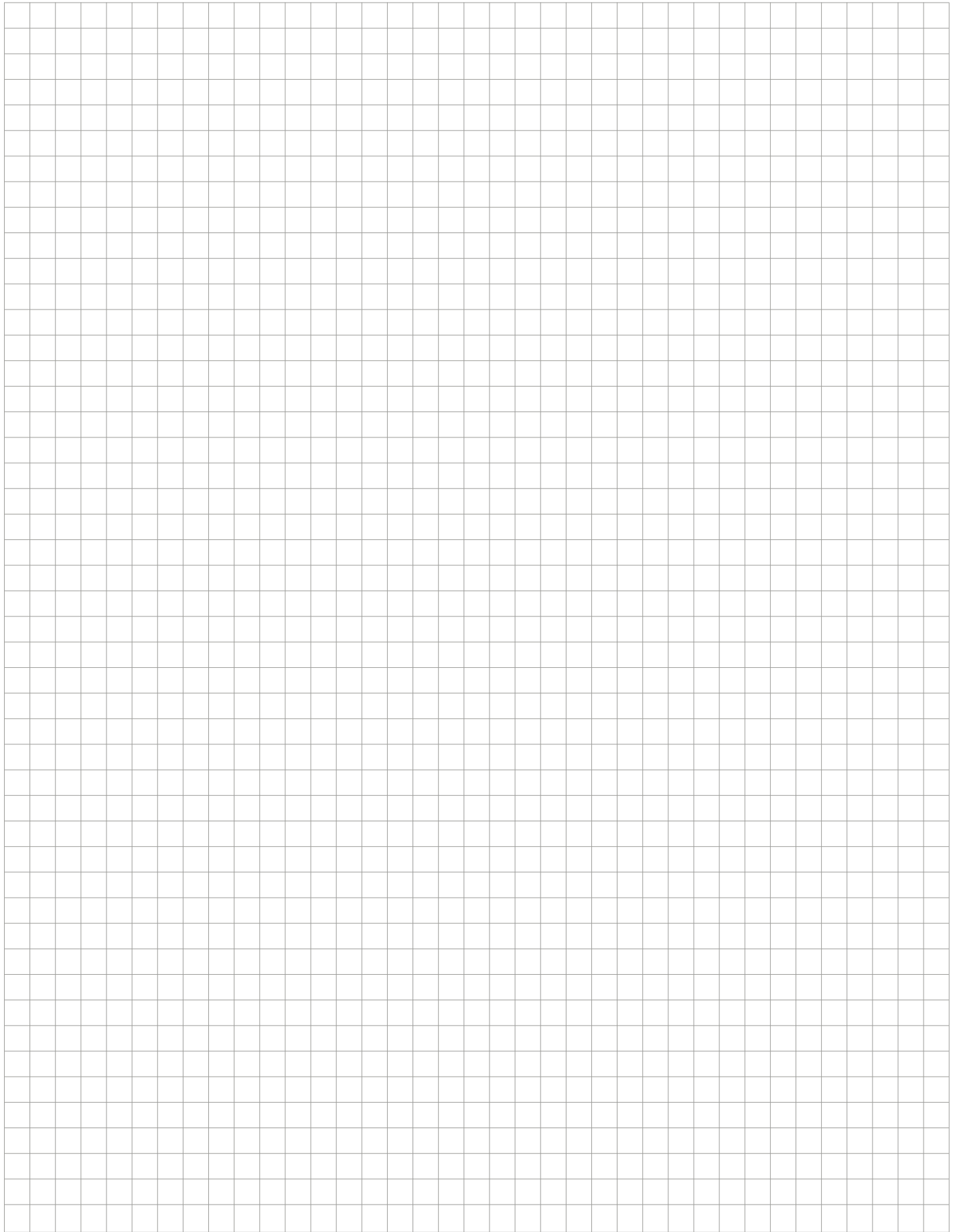

EMPODERAR A LAS PERSONAS QUE CONSTRUYEN EL FUTURO.

PROPÓSITO GERDAU CORSA

EMPODERAR
ES **COMPARTIR**
CONOCIMIENTO
CON QUIEN
PROYECTA
FUTURO.

Quando compartimos algo bueno que aprendimos, ampliamos el conocimiento colectivo y empoderamos a más personas para realizar mejor sus actividades y construir un futuro más colaborativo, diverso, inclusivo, sostenible y digital.

EMPODERAR
ES **APOYAR**
STARTUPS QUE
DESARROLLAN
SOLUCIONES
PARA EL FUTURO.

Ampliar la red, conectarse y aprender con quien está innovando en soluciones o en la forma de trabajar es empoderar personas para construir un futuro más colaborativo, diverso, inclusivo, sostenible y digital.

EMPODERAR
ES **COMPARTIR**
SU PUNTO DE VISTA
SOBRE ALGÚN
COMPORTAMIENTO.

Quando usted practica apertura y comparte su punto de vista sobre algún comportamiento de un colega, usted establece una conexión valiosa con el otro y también contribuye con su desarrollo. Esa también es una forma de empoderar personas para construir un futuro más colaborativo, diverso, inclusivo, sostenible y digital.

EMPODERAR
ES **PARTICIPAR**
DE PROYECTOS
SOCIALES.

Participar en iniciativas que impactan positivamente a la sociedad, nos aproxima a la construcción del mundo en que queremos vivir. Esa también es una forma de empoderar personas para construir un futuro más colaborativo, diverso, inclusivo, sostenible y digital.

EMPODERAR
ES **CONECTAR**
NECESIDADES
Y SOLUCIONES.

Oír al cliente con empatía y atenderlo de forma consultiva para ayudarlo a encontrar la mejor solución para su negocio, yendo más allá de sus expectativas, es una forma de empoderar personas para construir un futuro más colaborativo, diverso, inclusivo, sostenible y digital.

EMPODERAR
ES **COMPARTIR**
ERRORES
Y APRENDIZAJES.

Quando compartimos algún error y el aprendizaje que sacamos de una situación, ampliamos el conocimiento colectivo y permitimos que más gente aprenda con nuestra experiencia, evolucionando desde allí hacia una tentativa diferente de la nuestra. Esa también es una forma de empoderar personas para construir un futuro más colaborativo, diverso, inclusivo, sostenible y digital.

UNA PERSONA
EMPODERADA
VA Y LO HACE.

Quando usted identifica una oportunidad de hacer algo de una forma mejor, y va y pone a prueba su idea en la práctica, usted aprende de forma simple, rápida y barata y logra empoderar personas para construir un futuro más colaborativo, diverso, inclusivo, sustentable y digital.

OFICINAS COMERCIALES

T. (55) 5262 7300 / Av. Ejército Nacional 216 P.2,
Anzures, Miguel Hidalgo, CDMX 11590

PLANTAS**Cd. Sahagún**

T. (791) 913 8105 / Km. 3 Ctra. Mex – Cd. Sahagún,
Zona Ind. Tepeapulco, Cd. Sahagún, Hidalgo 43990

Tultitlán

T. (55) 5894 0044 / 2487 2065 / Primera Sur S/N, Independencia,
Tultitlán, Edo. de México 54915

La Presa

T. (55) 5003 4030 / 5062 1916 / Av. La Presa 2,
Zona Industrial La Presa, Tlalnepanitla, Edo. De México 54187

DISTRIBUCIÓN**CDMX**

T. (55) 5089 8930 / Año 1857 8, Ticomán,
Gustavo A. Madero, CDMX 07330

Irapuato

T. (46) 2627 0604 / Blvd. Solidaridad 8460,
Lázaro Cárdenas, Irapuato, Guanajuato 36540

Monterrey

T. (81) 8748 7610 / Blvd. Carlos Salinas de Gortari 404,
Centro Apodaca, Nuevo León 66600

PATIOS DE CHATARRA Y CENTROS DE RECOLECCIÓN**Cd. Sahagún**

T. (791) 9138105 / Km. 3 Ctra. Mex – Cd. Sahagún,
Zona Ind. Tepeapulco, Cd. Sahagún, Hidalgo 43990

Guadalajara

Tel. (33) 3668 0285/ 3670 2769 / Av. 18 de Marzo 531,
La Nogalera, Guadalajara, Jalisco 44470.

La Presa

T. (55) 5003 4030 / 5062 1916 / Av. La Presa 2,
Zona Industrial La Presa, Tlalnepanitla, Edo. de México 54187

Los Reyes

T. (55) 5856 1651 / Tepozanes Los Reyes,
Acaquilpan, México 56428

Patio San Juan

T. (55) 2603 3275 / 5262 7359 / San Juan 675,
Granjas Modernas, CDMX 07460

Tultitlán

T. (55) 5894 0044 / 2487 2065 / Primera Sur S/N, Independencia,
Tultitlán, Edo. de México 54915

Veracruz

T. (229) 9231359 / Ctra. Fed. Aluminio L.7 o
Caminote Roto Km. 1.5, Nuevo Veracruz, Veracruz 91726

**¡Danos Like!**

Gerdau Corsa México

**¡Síguenos!**

Gerdau Corsa Mx

**¡Únete!**

Gerdau Corsa

**¡Suscríbete!**

Gerdau Corsa